

SPECTRO Series

► SPECTRO-1-FIO-IR3

- Big working range: typ. 1 mm ... 500 mm (depends on the fiber optics used and attachment optics)
- Big assortment of fiber optics (reflected light or transmitted light, solely 67° types) and attachment optics
- IR LED, 1450 nm (AC-, DC-operation, can be switched or OFF in case of luminous objects)
- High scan frequency
- Gray scale detection (12-bit resolution)
- Insensitive to outside light (in AC-operation)
- Brightness correction can be activated (STAT/DYN)
- Averaging can be activated (from 1 up to over 32000 values)
- TEACH via PC or PLC
- 2 digital inputs (0V/+Ub)
- 2 digital outputs (max. 60 kHz switching frequency)
- 1 analog output (0V...+10V or 4...20mA), selectable via software
- Switching state indication by means of 2 yellow LEDs
- RS232 interface (USB or ETHERNET converter available)
- Parameterizable via Windows® software, scope function
- Temperature compensated (from 0°C to 60°C)
- Automatic threshold correction can be activated
- Switching threshold can be parameterized relative or absolute
- Various switching threshold functions (window, upper/lower threshold)
- Intensity control of luminous objects (LEDs, halogen lamps, displays, ...)

In Proud Partnership with Sensor Instruments

PAQUIN
SENSORS

For technical support, sales, & distribution
within the USA & Canada

www.paquin.com | (800) 831-8217 | paquinsensors@paquin.com

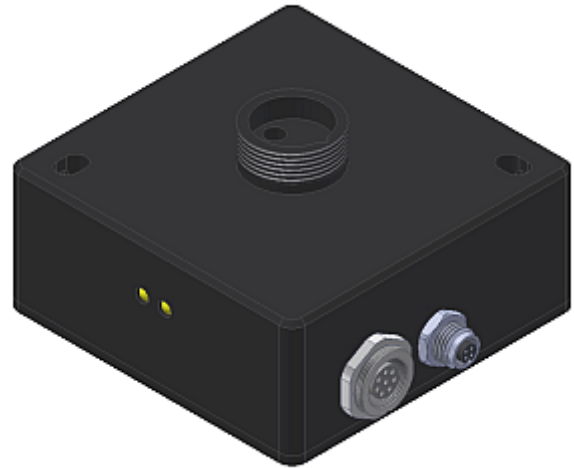

Design

Product name:

SPECTRO-1-FIO-IR3 (infrared LED, 1450 nm)
(incl. Windows® PC software SPECTRO1-Scope)

Fiber optics adaptor for
connection of fiber optics of
FIO series (solely 67° types)
(cf. separate data sheet)

Accessories: (p. 12-17)

Fiber optics
Optical frontends
Fiber optics fixtures

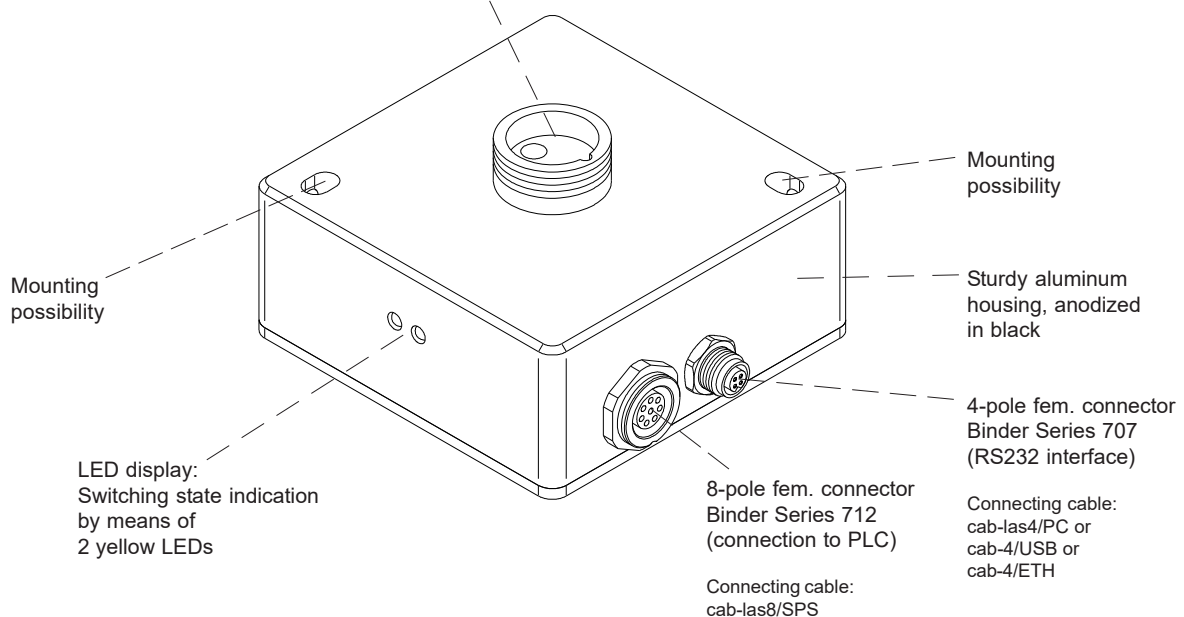



Technical Data

Model	SPECTRO-1-FIO-IR3		
Voltage supply	+24VDC (± 10%), reverse polarity protected, overcurrent protected		
Current consumption	< 160 mA		
Max. switching current	100 mA, short circuit proof		
Switching state indication	2 yellow LED visualize the physical state of the outputs OUT0 and OUT1		
Digital inputs (2x)	IN0 and IN1 (Pin 3 and 4): digital (0V/+24V)		
Digital outputs (2x)	OUT0 and OUT1 (Pin 5 and 6): digital (0V/+24V), npn/pnp-able (bright/dark-switching, can be switched)		
Analog output (1x)	ANALOG (Pin 8): voltage 0 ... +10V or current 4 ... 20mA, adjustable via PC software		
Interface	RS232		
Pulse lengthening	0 ... 100 ms, adjustable via PC software		
Averaging	max. 32768 values, adjustable via PC software		
Scan frequency (LED mode AC, DC or OFF, can be switched via PC software)	LED mode AC (depends on parameterization): Frequency [Hz] Digital outputs Analog output Max. 50 000 Off Off Max. 48 000 On Off Max. 42 000 Off On Max. 41 000 On On Measurements were made with the smallest gain at the receiver (AMP1). At the highest gain (AMP8), the frequency is reduced by a factor of 10.		LED mode DC / OFF (depends on parameterization): Frequency [Hz] Digital outputs Analog output Max. 175 000 Off Off Max. 135 000 On Off Max. 100 000 Off On Max. 85 000 On On The frequency is independent of the gain set at the receiver.
Switching frequency	max. 60 kHz		
Analog band width	max. 90 kHz (-3 dB)		
Transmitter (light source)	IR LED, 1450 nm		
Transmitter control	can be switched via PC software: AC operation (LED MODE-AC), DC operation (LED MODE-DC), OFF operation (LED MODE-OFF)		
Object distance (measuring range)	with reflected light fiber optics: typ. 1 mm ... 500 mm (depends on fiber optics and attachment optics) with transmitted light fiber optics: typ. 10 mm ... 500 mm (depends on fiber optics and attachment optics)		
Receiver	photo diode		
Receiver gain setting	8 steps (AMP1 ... AMP8), adjustable via PC software		
Ambient light	max. 5000 Lux		
Size of light spot	circular: typ. Ø 0.2 mm ... Ø 20 mm or rectangular: typ. 3 mm x 0.5 mm ... 6 mm x 1 mm depends on fiber optics and attachment optics (cf. catalog FIO series)		
Reproducibility	2 digits at 12-bit A/D conversion		
Housing dimensions	LXWxH approx. 65 mm x 65 mm x 36 mm (incl. fiber optics adaptor M18x1, without connectors)		
Housing material	aluminum, anodized in black		
Enclosure rating	IP64		
Connecting cables	to PLC: cab-las8/SPS or cab-las8/SPS-w to PC/RS232 interface: cab-las4/PC or cab-las4/PC-w to PC/USB interface: cab-4/USB or cab-4/USB-w to PC/Ethernet interface: cab-4/ETH		
Type of connector	connection to PLC: 8-pole fem. connector (Binder 712) connection to PC: 4-pole fem. connector (Binder 707)		
Operating temp. range	-20°C ... +55°C		
Storage temperature range	-20°C ... +85°C		
EMC test acc. to	DIN EN 60947-5-2		

Dimensions

SPECTRO-1-FIO-IR3

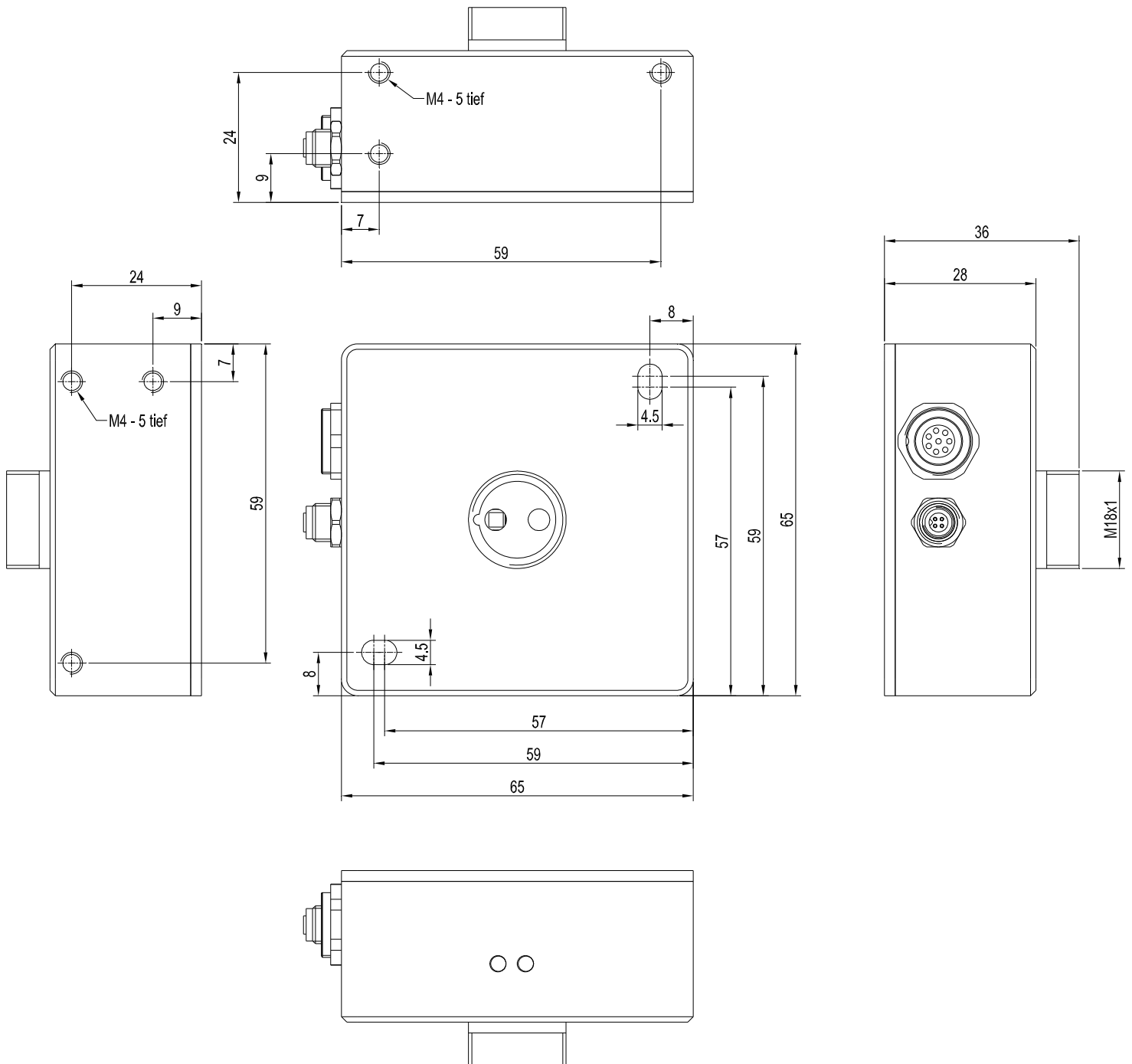

All dimensions in mm

Connector Assignment

Connection to PLC:**8-pole fem. connector Binder series 712**

Pin:	Color:	Assignment:
1	white	GND (0V)
2	brown	+24VDC ($\pm 10\%$)
3	green	IN0 (Digital 0: 0 ... 1V, Digital 1: +Ub - 10%)
4	yellow	IN1 (Digital 0: 0 ... 1V, Digital 1: +Ub - 10%)
5	grey	OUT0 (Digital 0: Type 0 ... 1V, Digital 1: Type +Ub - 10%)
6	pink	OUT1 (Digital 0: Type 0 ... 1V, Digital 1: Type +Ub - 10%)
7	blue	not connected
8	red	ANALOG (voltage 0...+10V <u>or</u> current 4...20mA)

Connecting cable:

cab-las8/SPS-(length)
cab-las8/SPS-w-(length)
(standard length 2m)

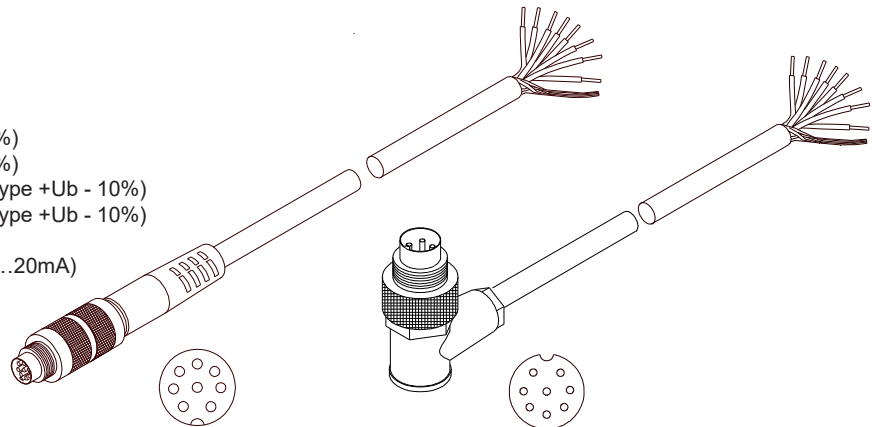

cab-las8/SPS-...
(max. length 25m, outer jacket: PUR)

cab-las8/SPS-w-...
(max. length 25m, outer jacket: PUR)

Connection to PC:**4-pole fem. connector Binder Series 707**

Pin:	Assignment:
1	+24VDC (+Ub, OUT)
2	GND (0V)
3	RxD
4	TxD

Connection via RS232 interface at the PC:

Connecting cable:
cab-las4/PC-(length)
cab-las4/PC-w-(length) (angle type 90°)
(standard length 2m)

alternative:**Connection via USB interface at the PC:**

USB converter (incl. driver software):
cab-4/USB-(length)
cab-4/USB-w-(length) (angle type 90°)
(standard length 2m)

alternative:**Connection to local network via Ethernet bus:**

Ethernet converter (incl. software „SensorFinder“):
cab-4/ETH-500
(standard length 0.5m)

Optional: External CAT5 cable, e.g.

cab-eth/M12D-RJ45-flx-(length)

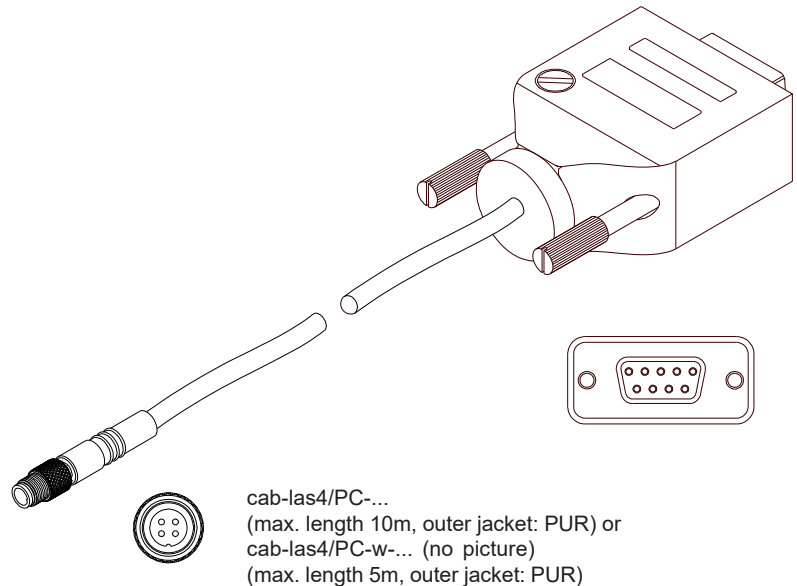

cab-las4/PC-...
(max. length 10m, outer jacket: PUR) or
cab-las4/PC-w-... (no picture)
(max. length 5m, outer jacket: PUR)

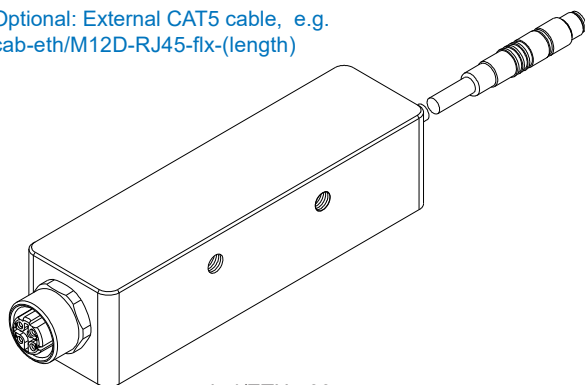

cab-4/ETH-500
(length 0.5m, outer jacket: PUR)
4-pole M12 fem. conn. (D-coded)
for connection of an external
CAT5 cable, e.g.
cab-eth/M12D-RJ45-flx-(length)

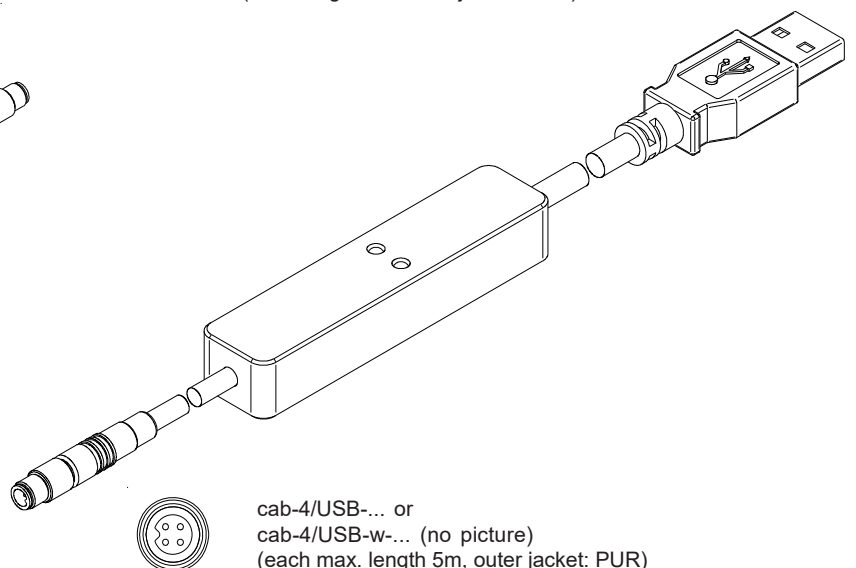

cab-4/USB-... or
cab-4/USB-w-... (no picture)
(each max. length 5m, outer jacket: PUR)



LED Display

LED display:

By means of the two LEDs the physical state of the two outputs OUT0 and OUT1 is visualized:

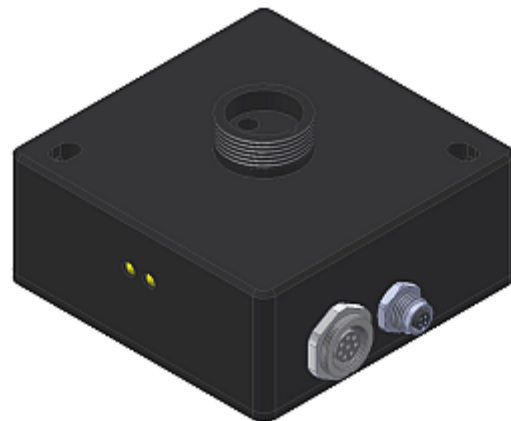
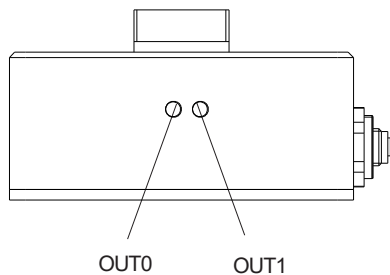

Measuring Principle

Measuring principle of the sensors of SPECTRO-1 series:

The sensors of the SPECTRO-1 series are of single-channel design, i.e. they acquire the analog signal that comes from a receiver and evaluate this signal. Various light sources such as white light, UV light, IR light, or a laser can be used as a transmitter. The receiver is correspondingly matched to the transmitter. The acquired analog signal is provided through a voltage output and a current output.

The software can be used to select various evaluation modes for the analog signal. The status of the analog signal is provided through 2 digital outputs in accordance with the selected evaluation mode. A digital input allows external "teaching" of the sensor. An additional input allows the "freezing" of the analog output signal upon a positive input edge.

The SPECTRO-1 sensor allows highly flexible signal acquisition. The sensor, for example, can be operated in alternating-light mode (AC mode), which means the sensor is not influenced by external light, or in constant-light mode (DC mode), which provides outstanding high-speed sensor operation. An OFF function deactivates the sensor's integrated light source and changes to DC mode, which allows the sensor to detect so-called "self-luminous objects". With the stepless adjustment of the integrated light source, the selectable gain of the receiver signal, and an INTEGRAL function the sensor can be adjusted to almost any surface or any "self-luminous object".

A micro-controller performs 12-bit analog/digital conversion of the analog signal, which allows recording and evaluation of the signal. Furthermore the SPECTRO-1 sensor offers various options for intelligent signal processing such as e.g. dirt accumulation compensation.

Parameters and measurement values can be exchanged between PC and sensor either through RS232 or Ethernet (using an Ethernet converter, e.g. cab-4/ETH-500). Through the interface all the parameters can be stored in the non-volatile EEPROM of the sensor. The PC software facilitates the parameterisation, diagnostics, and adjustment of the sensor system (oscilloscope function). The software furthermore provides a data recorder function that automatically records data and stores them on the hard disk of the PC. SPECTRO-1 sensors are temperature-compensated over a range of 0°C to 80°C.

Possible firmware updates can be easily performed through the RS232 interface, even with the sensor system in installed condition. When parameterisation is finished, the color sensor continues to operate with the current parameters in STAND-ALONE mode without a PC.



Parameterization

Windows® user interface:

(The current software version is available for download on our website.)

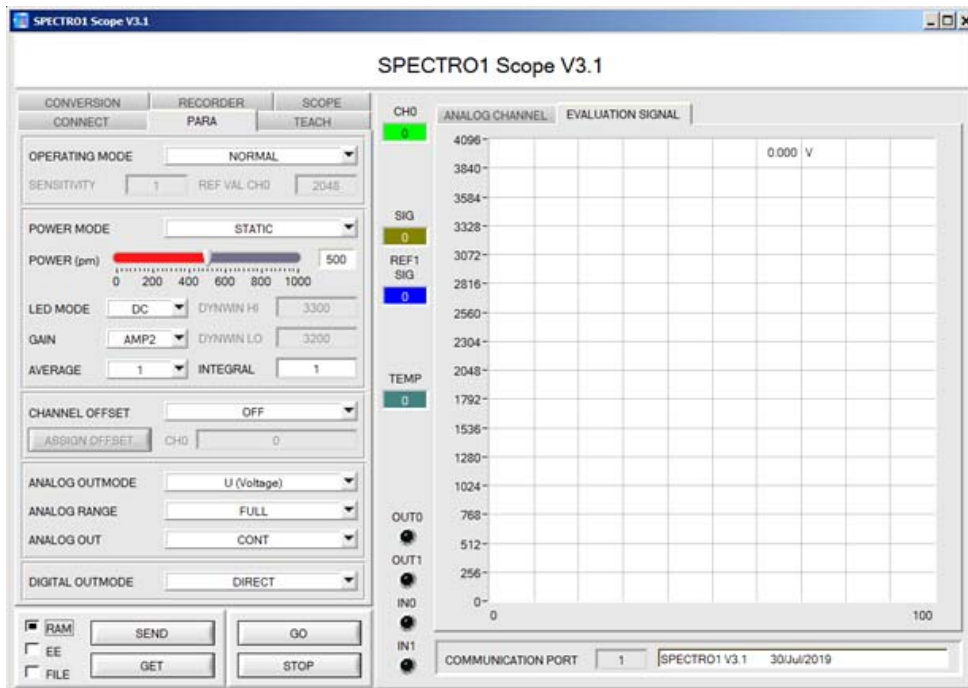

The PC software SPECTRO1-Scope facilitates the parameterization, the diagnosis, and the adjustment of the sensor system (oscilloscope function). Moreover, the software features a data recorder function that allows the automatic recording of recorded data and the saving of those at the hard disk of the PC.

Parameters and measurement values can be exchanged between PC and sensor either through RS232 or Ethernet (using an Ethernet converter). Through the interface all the parameters can be stored in the non-volatile EEPROM of the sensor.

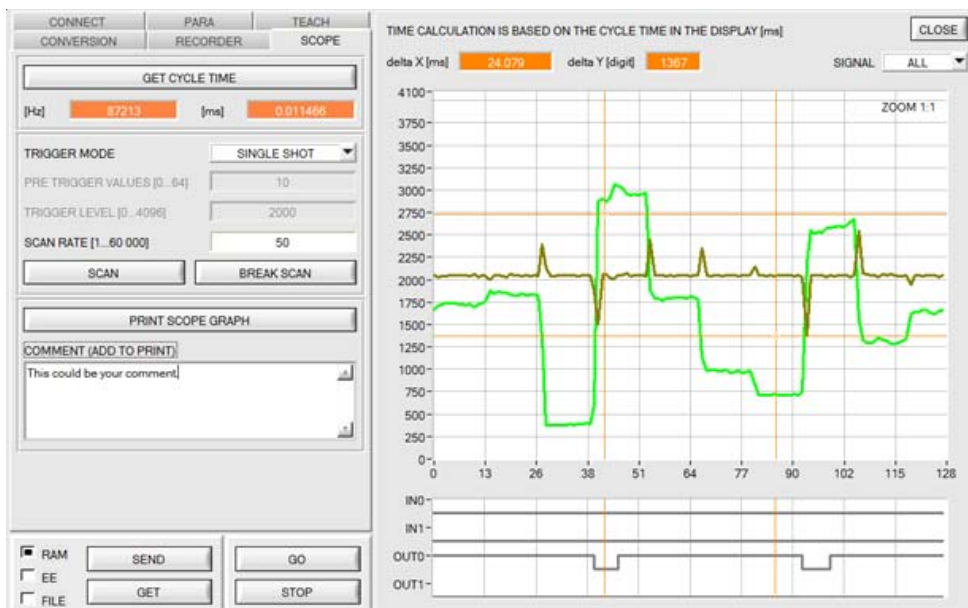

The SCOPE tab visualises an oscilloscope.



Firmware Update

Firmware update by means of the software „FirmwareLoader“:

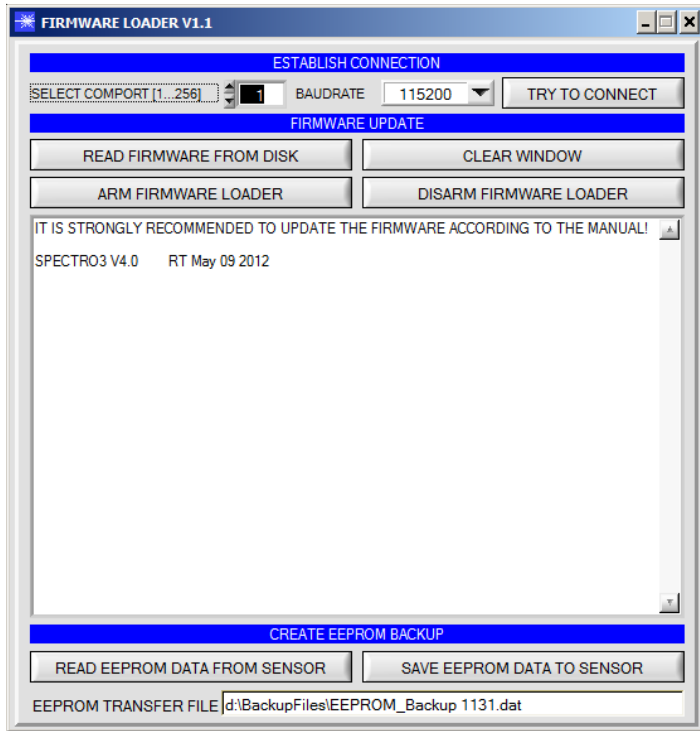

The software „Firmware Loader“ allows the user to perform an automatic firmware update. The update will be carried out through the RS232 interface.

An initialisation file (xxx.ini) and a firmware file (xxx.elf.S) are required for performing a firmware update. These files can be obtained from your supplier. In some cases an additional firmware file for the program memory (xxx.elf.p.S) is also needed, and this file will be automatically provided together with the other two files.



Diagrams

Diagrams: SPOT DIAMETER depending on distance

SPOT DIAMETER [distance], typ.

SPECTRO-1-FIO-IR, -B, -R
with fiber optics R-S-A1.1-(0.6)-1200-67°
and attachment optics KL-4
(fiber optics fixed at limit stop into attachment optics)

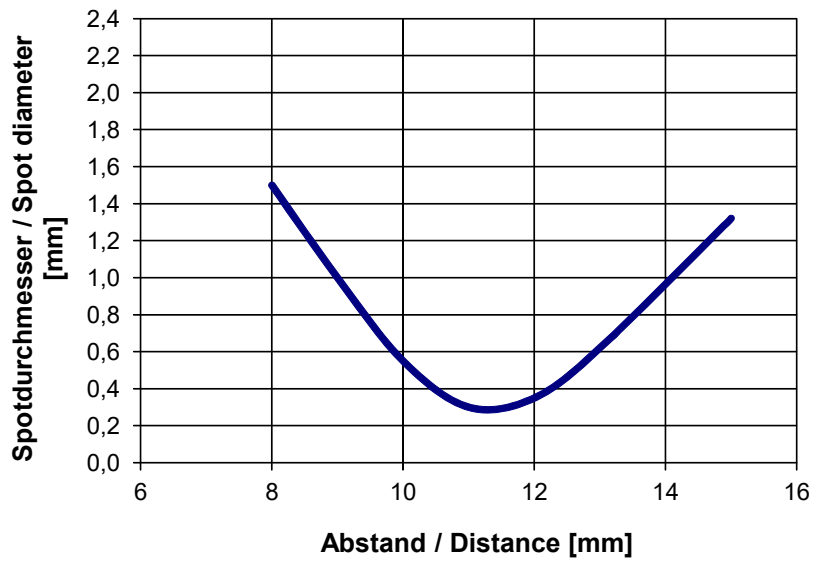

SPOT DIAMETER [distance], typ.

SPECTRO-1-FIO-IR, -B, -R
with fiber optics R-S-A1.1-(1.1)-1200-67°
and attachment optics KL-4
(fiber optics fixed at limit stop into attachment optics)

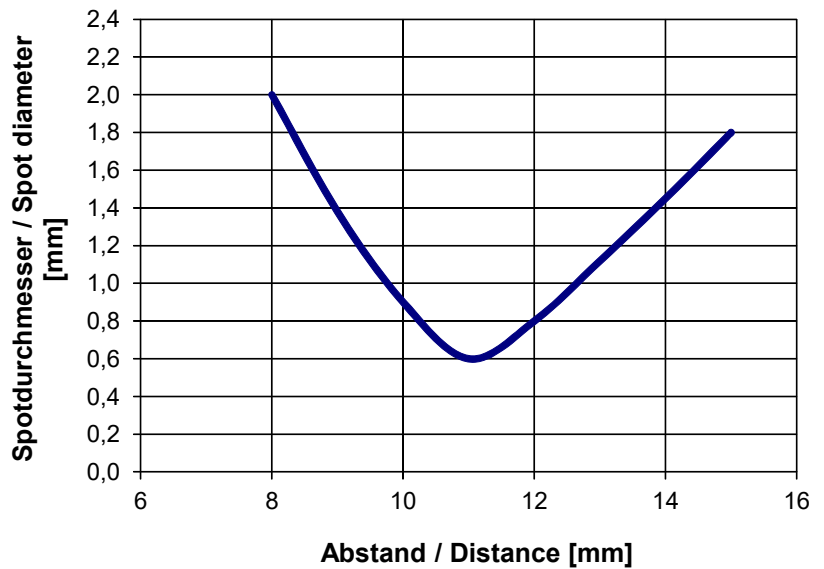

SPOT DIAMETER [distance], typ.

SPECTRO-1-FIO-IR, -B, -R
with fiber optics R-S-A1.1-(1.5)-1200-67°
and attachment optics KL-4
(fiber optics fixed at limit stop into attachment optics)

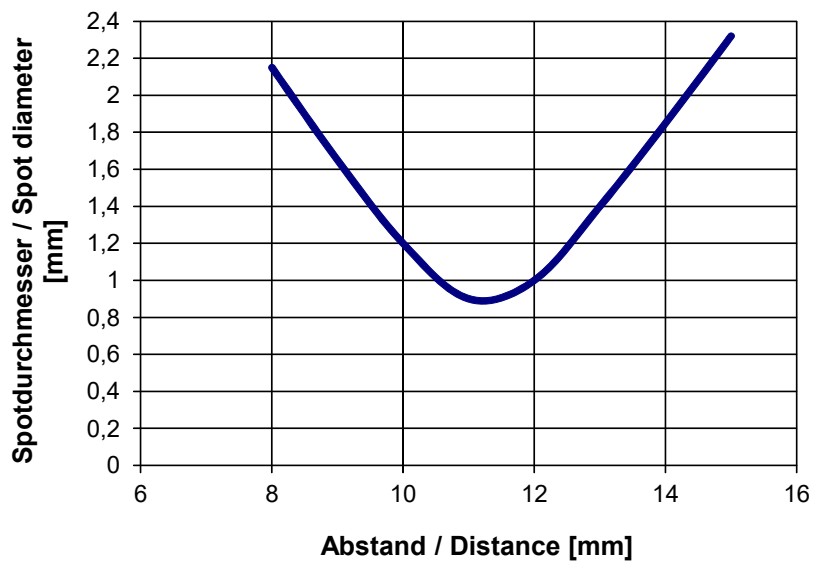



Diagrams

Diagrams: SPOT DIAMETER depending on object distance

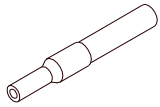

Fiber bundle Ø 2.5 mm

SPOT DIAMETER [distance], typ.

SPECTRO-1-FIO-IR, -B, -R
with fiber optics R-P-A2.0-(2.5)-600-67°

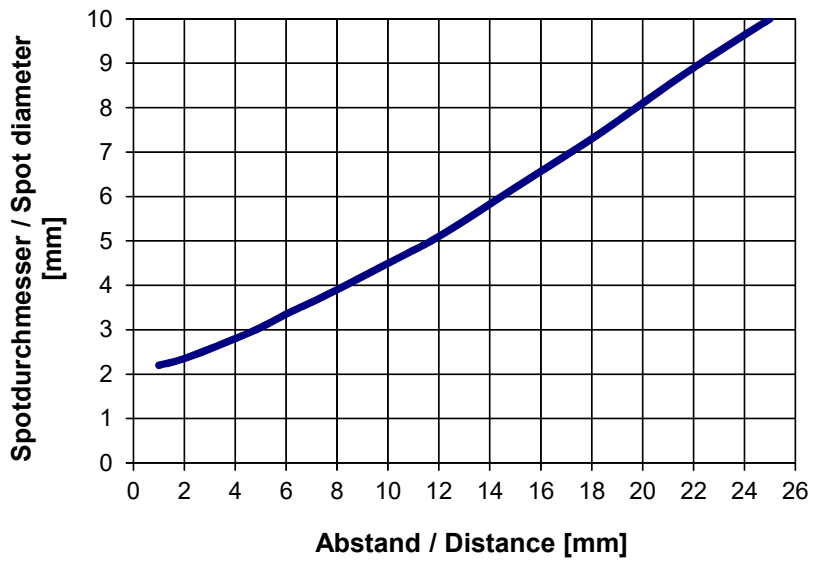

SPOT DIAMETER [distance], typ.

SPECTRO-1-FIO-IR, -B, -R
with fiber optics R-S-A2.0-(2.5)-1200-67°
and attachment optics KL-3
(fiber optics is inner stop fixed to attachment optics)

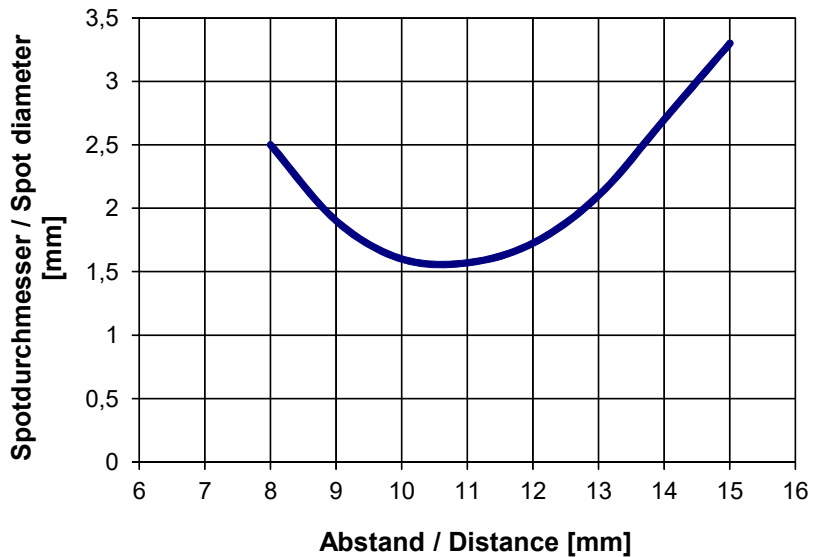

SPOT DIAMETER [distance], typ.

SPECTRO-1-FIO-IR, -B, -R
with fiber optics R-S-A2.0-(2.5)-1200-67°
and attachment optics KL-M18-A2.0
(fiber optics is inner stop fixed to attachment optics)

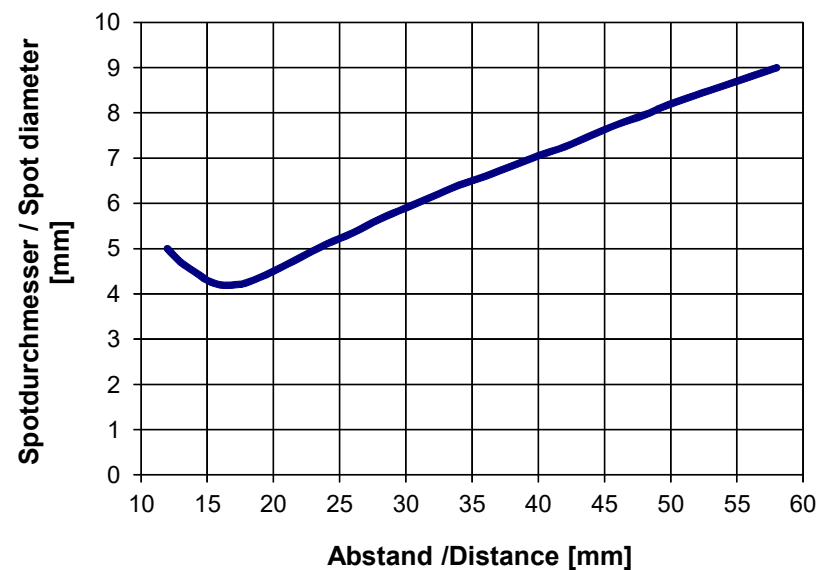



Diagrams

Diagrams: SPOT DIAMETER depending on object distance

SPOT DIAMETER [distance], typ.

SPECTRO-1-FIO-IR, -B, -R
with fiber optics R-S-A2.0-(2.5)-1200-67°
and attachment optics KL-M34-A2.0
(fiber optics is inner stop fixed to attachment optics)

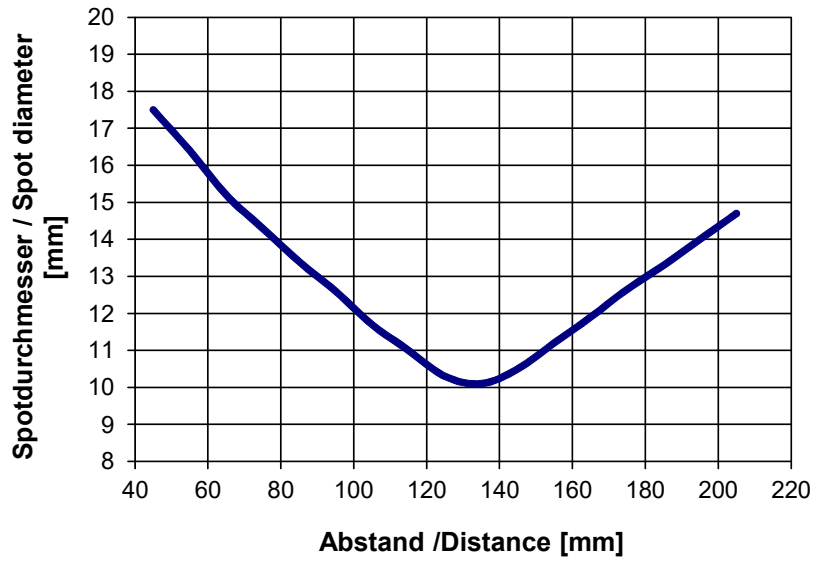

SPOT DIAMETER [distance], typ.

SPECTRO-1-FIO-IR, -B, -R
with fiber optics R-S-A3.0-(3.0)-1200-67°

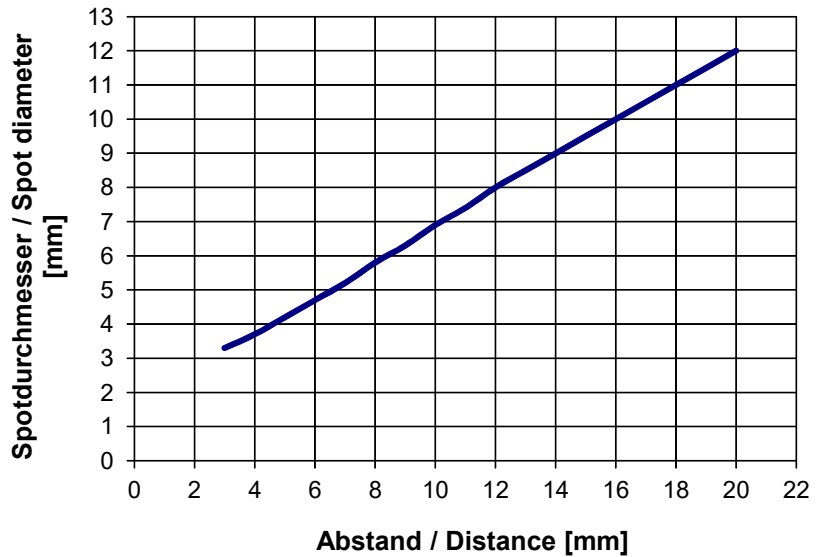

◆ short semiaxis
● long semiaxis

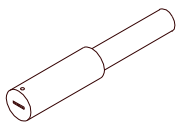

Fiber gap 6 mm x 1 mm

SPOT DIAMETER [distance], typ.

SPECTRO-1-FIO-IR, -B, -R
with fiber optics R-S-R2.1-(6x1)-1200-67°

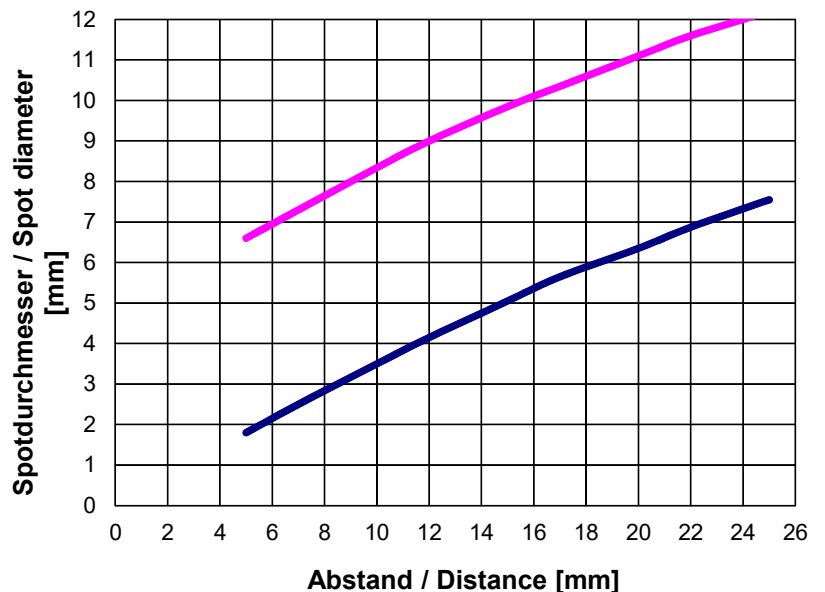



Diagrams

Diagrams: RELATIVE INTENSITY depending on the distance of the object (white paper) to the fiber optics head

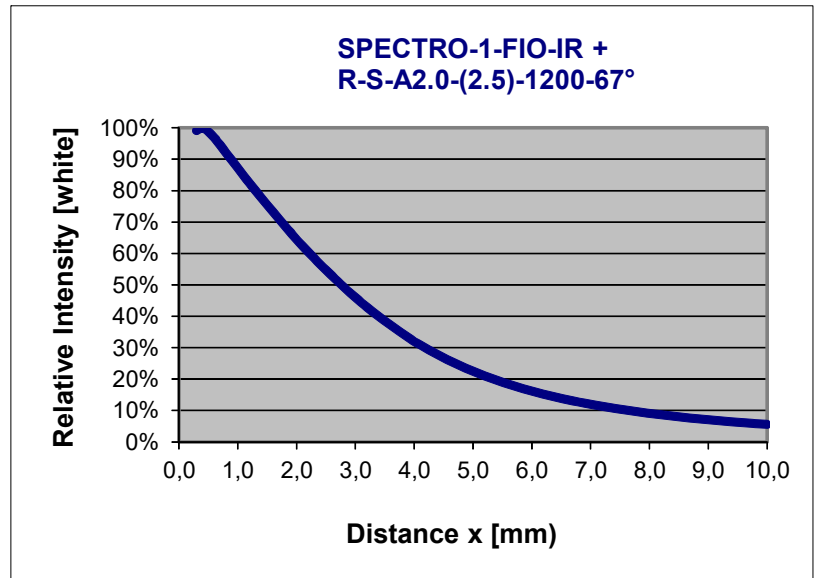

Relative Intensity SPECTRO-1-FIO-IR with fiber optics R-S-A2.0-(2.5)-1200-67° 100% at object distance 0.4 mm (INTENSITY 4040)

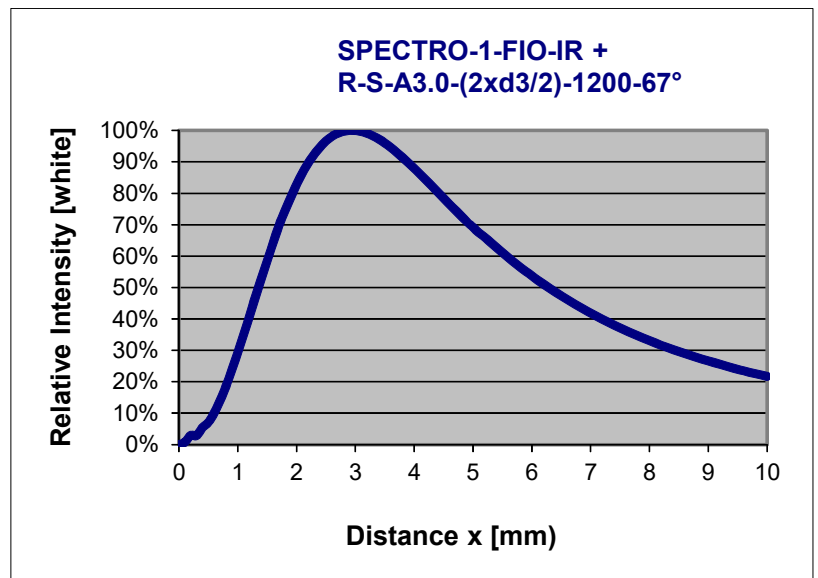

Relative Intensity SPECTRO-1-FIO-IR with fiber optics R-S-A3.0-(2xd3/2)-1200-67° 100% at object distance 3.0 mm (INTENSITY 4095)

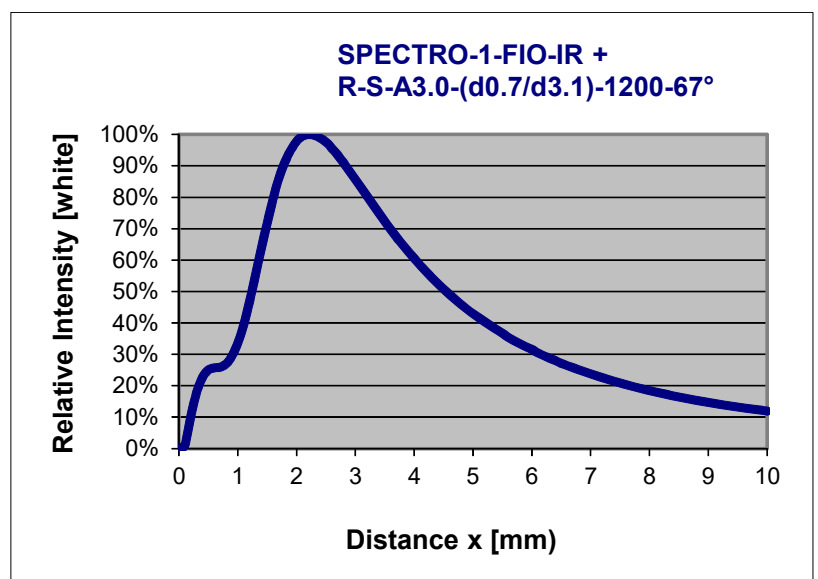

Relative Intensity SPECTRO-1-FIO-IR with fiber optics R-S-A3.0-(d0.7/d3.1)-1200-67° 100% at object distance 2.2 mm (INTENSITY 3890)



Fiber Optics

Field of use of optical fibers of FIO Series:

Optical fibers offer solutions for difficult tasks in optoelectronics. They can be used universally and allow flexible applications.

Advantages:

- Highest quality
- Selection from different fiber types
- Thermal stability
- Great variety of available standard sensor heads
- Special designs
- Various attachment optics available

Available special fiber optics
(for use with external light source ELS-IRL-FIO):

R-S-A1.1-(1.5)-1200-Y-67°/67°

R-S-A2.0-(2.5)-1200-Y-67°/67°

R-S-A3.0-(3.0)-1200-Y-67°/67°

R-S-R1.1-(3x0.5)-1200-Y-67°/67°

R-S-R2.1-(6x1)-1200-Y-67°/67°



Please note:

For operation with the SPECTRO-1-FIO-IR3 solely optical fibers with a beam opening angle of 67° are to be used!

Characteristics:

Light-conducting glass fibers are optical components that allow the transmission of light through any curved path based on the principle of total reflection.

The individual fiber is composed of high-break core glass and low-break cladding glass. The light beams entering the core glass within the critical angle are guided through the fiber by way of reflection at the core/cladding contact surfaces (step index fiber).

The highly flexible optical fibers are made of bundled individual glass fibers. The ends are each glued into a sensor head and a connector. The faces are optically polished. For protection against mechanical, chemical, or thermal destruction the optical fibers are provided with a corresponding protective sheath.

Order Code:

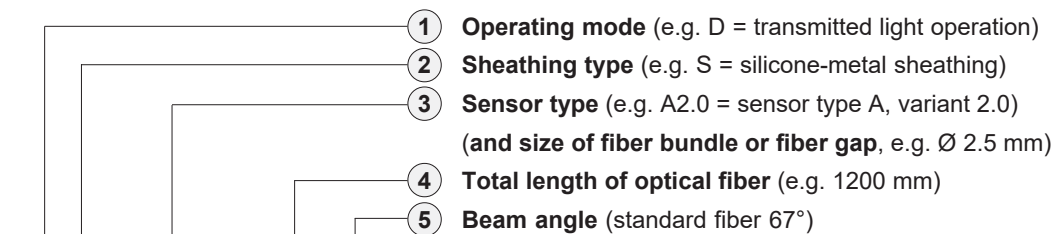

D-S-A2.0-(2.5)-1200-67°

Order code for optical fiber

(For detailed description of the various types of fiber optics, please cf. catalog „FIO Series“)

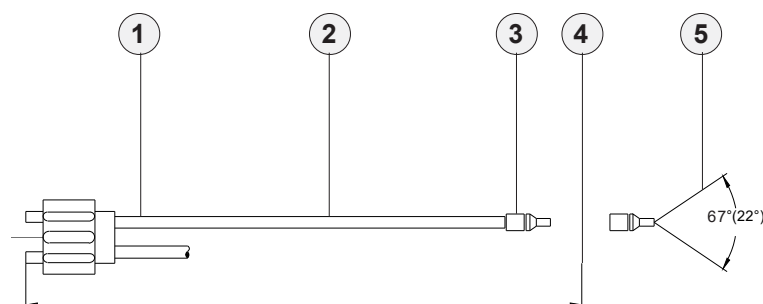

Dimensions of adapter

Attachment optics (e.g. focus lens, reflex optics, prism optics)

Fiber optics for reflex light operation

Fiber optics for transmitted light operation

Mounting hints

cf. catalog FIO Series

cf. catalog FIO Series

cf. catalog FIO Series

cf. catalog FIO Series

cf. catalog FIO Series



Optical Frontends

Overview: Optical frontends for fiber optics:



KL-1-A2.0



KL-2-A2.0



KL-3-A2.0
KL-4-A1.1
KL-5-R1.1
KL-8-R2.1
KL-9-A3.0



KL-3/90°-A2.0
KL-8/90°-A2.0



KL-M12/90°-XL-A2.0



KL-90-A2.0



KL-52-XL-A3.0



KL-M8-A1.1



KL-M12-A1.1
KL-M12-A2.0
KL-M12-A3.0
KL-M12-R1.1



KL-M12-XL-A1.1
KL-M12-XL-A2.0
KL-M12-XL-R1.1



KL-M18-A1.1
KL-M18-A2.0
KL-M18-A3.0
KL-M18-M5.0
KL-M18-M6.0
KL-M18-M8.0
KL-M18-R1.1
KL-M18-R2.1



KL-M18-XL-A1.1
KL-M18-XL-A2.0
KL-M18-XL-A3.0
KL-M18-XL-M5.0
KL-M18-XL-M6.0
KL-M18-XL-M8.0
KL-M18-XL-R1.1
KL-M18-XL-R2.1



KL-M34-A1.1
KL-M34-A2.0
KL-M34-A3.0
KL-M34-M5.0
KL-M34-M6.0
KL-M34-M8.0
KL-M34-R1.1
KL-M34-R2.1



KL-M34-XL-A1.1
KL-M34-XL-A2.0
KL-M34-XL-A3.0
KL-M34-XL-M5.0
KL-M34-XL-M6.0
KL-M34-XL-M8.0
KL-M34-XL-R1.1
KL-M34-XL-R2.1



KL-M34/62-A1.1
KL-M34/62-A2.0
KL-M34/62-A3.0
KL-M34/62-R1.1
KL-M34/62-R2.1



KL-D-0°/2.5°-300-A2.0



KL-D-0°/40°-9-A2.0
KL-D-0°/42°-9-A2.0



KL-D-0°/45°-30-A2.0
KL-D-0°/45°-30-A3.0



KL-D-5°-85-POL-A2.0
KL-D-5°-85-POL-A3.0



KL-D-6°-200-A2.0



KL-D-10°-45-POL°-A3.0



KL-D-14°-84-A2.0



KL-D-17°-49-A2.0



KL-D-20°-31-A2.0



KL-D-20°-20-POL-A3.0



KL-D-28°-26-A2.0



KL-D-40°-13-A2.0

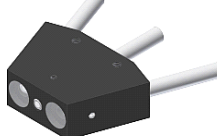

KL-D-40°-23-5/DIF-A2.0
KL-D-40°-23-5/DIF-A3.0



KL-D-45°-14-A2.0



KL-D-M12-0°/30°-9-A2.0
KL-D-M12-0°/30°-9-A3.0



KL-D-M12-XL-0°/30°-30-A2.0



KL-M34/90°-XL



KL-M18-XL-0°/(17°-60°)-30-M5.0

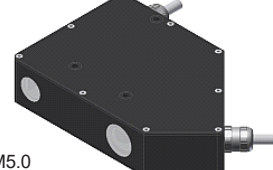

KL-D-0°/45°-85-1200-A3.0





Optical Frontends

Optical frontends for reflected light or transmitted light fiber optics:

Part number:	Suitable for fiber optics type: (R, T = reflected light, D= transmitted light)	Characteristics:
KL-1-A2.0 (2 pcs. necessary)	D-S-A2.0-(2.5)-...-67°	Transmitter/receiver distance typ. 50 mm ... 200 mm
KL-2-A2.0	R-S-A2.0-(2.5)-...-67°	Transmitter/receiver distance max. 300 mm, beam divergency ± 7,5°
KL-2-A2.0 (2 pcs. necessary)	D-S-A2.0-(2.5)-...-67°	Transmitter/receiver distance max. 300 mm, beam divergency ± 7,5°
KL-3-A2.0	R-S-A2.0-(2.5)-...-67°	Working distance typ. 10 mm ... 20 mm
KL-D-3/30-R/D-A2.0	R/D-S-A2.0-(2.5)-1200-67° <i>Special version*</i>	Working distance typ. 30 mm
KL-4-A1.1	R-S-A1.1-(0.6)-...-67°	Working distance typ. 10 mm ... 15 mm
KL-4-A1.1	R-S-A1.1-(1.1)-...-67°	Working distance typ. 10 mm ... 15 mm
KL-4-A1.1	R-S-A1.1-(1.5)-...-67°	Working distance typ. 10 mm ... 15 mm
KL-5-R1.1	R-S-R1.1-(3x0.5)-...-67°	Working distance typ. 8 mm ... 20 mm
KL-8-R2.1	R-S-R2.1-(6x1)-...-67°	Working distance typ. 8 mm ... 25 mm
KL-8-N-R2.1	R-S-R2.1-(6x1)-...-67°	Working distance typ. 8 mm ... 25 mm <i>with guide slot (adjustment aid)</i>
KL-8/90°-R2.1	R-S-R2.1-(6x1)-...-67°	Working distance typ. 8 mm ... 25 mm
KL-9-A3.0	R-S-A3.0-(3.0)-...-67°	Working distance typ. 8 mm ... 25 mm
KL-90-A2.0 (2 pcs. necessary)	D-S-A2.0-(2.5)-...-67°	Working distance typ. 20 mm ... 100 mm <i>prismatic optics</i>
KL-52-XL-A3.0	R-S-A3.0-(3.0)-...-67°	Optikdurchmesser 52 mm
KL-M8-A1.1	R-S-A1.1-(1.5)-...-67°	Working distance typ. 8 mm ... 20 mm
KL-M12-A1.1	R-S-A1.1-(1.5)-...-67°	Working distance typ. 8 mm ... 40 mm
KL-M12-A2.0	R-S-A2.0-(2.5)-...-67°	Working distance typ. 8 mm ... 40 mm
KL-M12-A3.0	R-S-A3.0-(3.0)-...-67°	Working distance typ. 8 mm ... 40 mm
KL-M12-R1.1	R-S-R1.1-(3x0.5)-...-67°	Working distance typ. 8 mm ... 40 mm
KL-M12-XL-A1.1	R-S-A1.1-(1.5)-...-67°	Working distance typ. 10 mm ... 100 mm
KL-M12-XL-A2.0	R-S-A2.0-(2.5)-...-67°	Working distance typ. 10 mm ... 100 mm
KL-M12/90°-XL-A2.0	R-S-A2.0-(2.5)-...-67°	Working distance typ. 10 mm ... 100 mm
KL-M12-XL-R1.1	R-S-R1.1-(3x0.5)-...-67°	Working distance typ. 10 mm ... 100 mm
KL-M18-A1.1	R-S-A1.1-(1.5)-...-67°	Working distance typ. 20 mm ... 60 mm
KL-M18-A2.0	R-S-A2.0-(2.5)-...-67°	Working distance typ. 20 mm ... 60 mm
KL-M18-A3.0	R-S-A3.0-(3.0)-...-67°	Working distance typ. 20 mm ... 60 mm
KL-M18-M5.0	T-S-M5.0-(5.0)-...-67° <i>Special version*</i>	Working distance typ. 20 mm ... 60 mm
KL-M18-M6.0	T-S-M6.0-(6.0)-...-67° <i>Special version*</i>	Working distance typ. 20 mm ... 60 mm
KL-M18-M8.0	T-S-M8.0-(8.0)-...-67° <i>Special version*</i>	Working distance typ. 20 mm ... 60 mm
KL-M18-R1.1	R-S-R1.1-(3x0.5)-...-67°	Working distance typ. 20 mm ... 60 mm
KL-M18-R2.1	R-S-R2.1-(6x1)-...-67°	Working distance typ. 20 mm ... 60 mm
KL-M18-XL-A1.1	R-S-A1.1-(1.5)-...-67°	Working distance typ. 10 mm ... 200 mm
KL-M18-XL-A2.0	R-S-A2.0-(2.5)-...-67°	Working distance typ. 10 mm ... 200 mm
KL-M18-XL-A3.0	R-S-A3.0-(3.0)-...-67°	Working distance typ. 10 mm ... 200 mm
KL-M18-XL-M5.0	T-S-M5.0-(5.0)-...-67° <i>Special version*</i>	Working distance typ. 10 mm ... 200 mm
KL-M18-XL-M6.0	T-S-M6.0-(6.0)-...-67° <i>Special version*</i>	Working distance typ. 10 mm ... 200 mm
KL-M18-XL-M8.0	T-S-M8.0-(8.0)-...-67° <i>Special version*</i>	Working distance typ. 10 mm ... 200 mm
KL-M18-XL-R1.1	R-S-R1.1-(3x0.5)-...-67°	Working distance typ. 10 mm ... 200 mm
KL-M18-XL-R2.1	R-S-R2.1-(6x1)-...-67°	Working distance typ. 10 mm ... 200 mm
KL-M18-XL--0°/(17°-60°)-30-M5.0	2x T-S-M5.0-(5.0)-...-67° <i>Special version*</i>	Angle between the two fiber optics is adjustable from 17° to 60°

*Special version:

Version is different to the standard version (e.g. no standard fiber adapter) and therefore is suitable only for certain sensors or applications



Optical Frontends

Optical frontends for reflected light or transmitted light fiber optics:

Part number:	Suitable for fiber optics type: (R, T = reflected light, D= transmitted light)	Characteristics:
KL-M34-A1.1	R-S-A1.1-(1.5)-...-67°	Working distance typ. 100 mm ... 250 mm
KL-M34-A2.0	R-S-A2.0-(2.5)-...-67°	Working distance typ. 100 mm ... 250 mm
KL-M34-A3.0	R-S-A3.0-(3.0)-...-67°	Working distance typ. 100 mm ... 250 mm
KL-M34-M5.0	T-S-M5.0-(5.0)-...-67° <i>Special version*</i>	Working distance typ. 100 mm ... 250 mm
KL-M34-M6.0	T-S-M6.0-(6.0)-...-67° <i>Special version*</i>	Working distance typ. 100 mm ... 250 mm
KL-M34-M8.0	T-S-M8.0-(8.0)-...-67° <i>Special version*</i>	Working distance typ. 100 mm ... 250 mm
KL-M34-R1.1	R-S-R1.1-(3x0.5)-...-67°	Working distance typ. 100 mm ... 250 mm
KL-M34-R2.1	R-S-R2.1-(6x1)-...-67°	Working distance typ. 100 mm ... 250 mm
KL-M34-XL-A1.1	R-S-A1.1-(1.5)-...-67°	Working distance typ. 50 mm ... 400 mm
KL-M34-XL-A2.0	R-S-A2.0-(2.5)-...-67°	Working distance typ. 50 mm ... 400 mm
KL-M34-XL-A3.0	R-S-A3.0-(3.0)-...-67°	Working distance typ. 50 mm ... 400 mm
KL-M34-XL-M5.0	T-S-M5.0-(5.0)-...-67° <i>Special version*</i>	Working distance typ. 50 mm ... 400 mm
KL-M34-XL-M6.0	T-S-M6.0-(6.0)-...-67° <i>Special version*</i>	Working distance typ. 50 mm ... 400 mm
KL-M34-XL-M8.0	T-S-M8.0-(8.0)-...-67° <i>Special version*</i>	Working distance typ. 50 mm ... 400 mm
KL-M34-XL-(M25x1.5)-M8.0	T-S-M8.0-(8.0)-...-67° <i>Special version*</i>	as above but with cable screw fitting M25x1.5
KL-M34-XL-R1.1	R-S-R1.1-(3x0.5)-...-67°	Working distance typ. 50 mm ... 400 mm
KL-M34-XL-R2.1	R-S-R2.1-(6x1)-...-67°	Working distance typ. 50 mm ... 400 mm
KL-M34/62-A1.1	R-S-A1.1-(1.5)-...-67°	Working distance typ. 80 mm ... 200 mm
KL-M34/62-A2.0	R-S-A2.0-(2.5)-...-67°	Working distance typ. 80 mm ... 200 mm
KL-M34/62-A3.0	R-S-A3.0-(3.0)-...-67°	Working distance typ. 80 mm ... 200 mm
KL-M34/62-R1.1	R-S-R1.1-(3x0.5)-...-67°	Working distance typ. 80 mm ... 200 mm
KL-M34/62-R2.1	R-S-R2.1-(6x1)-...-67°	Working distance typ. 80 mm ... 200 mm
KL-D-0°/2.5°-300-A2.0	D-S-A2.0-(2.5)-...-67°	Working distance typ. 100 mm ... 500 mm
KL-D-0°/40°-9-A2.0	D-S-A2.0-(2.5)-...-67°	(to be supplemented)
KL-D-0°/42°-9-A2.0	D-S-A2.0-(2.5)-...-67°	(to be supplemented)
KL-D-0°/45°-30-A2.0	D-S-A2.0-(2.5)-...-67°	(to be supplemented)
KL-D-0°/45°-30-A3.0	D-S-A3.0-(3.0)-...-67°	(to be supplemented)
KL-D-5°-85-POL-A2.0	D-S-A2.0-(2.5)-...-67°	(to be supplemented)
KL-D-5°-85-POL-A3.0	D-S-A3.0-(3.0)-...-67°	(to be supplemented)
KL-D-6°-200-A2.0	D-S-A2.0-(2.5)-...-67°	Working distance typ. 100 mm ... 230 mm
KL-D-14°-84-A2.0	D-S-A2.0-(2.5)-...-67°	Working distance typ. 60 mm ... 120 mm
KL-D-14°-84-A2.0-T400	D-S-A2.0-(2.5)-1200-67°-T400	Working distance typ. 60 mm ... 120 mm <i>thermally stable up to 400°C</i>
KL-D-17°-49-A2.0	D-S-A2.0-(2.5)-...-67°	Working distance typ. 30 mm ... 80 mm
KL-D-20°-31-A2.0	D-S-A2.0-(2.5)-...-67°	Working distance typ. 10 mm ... 50 mm
KL-D-28°-26-A2.0	D-S-A2.0-(2.5)-...-67°	Working distance typ. 20 mm ... 50 mm
KL-D-28°-26-KG2-A2.0	D-S-A2.0-(2.5)-...-67°	Working distance typ. 20 mm ... 50 mm
KL-D-30°-23-A2.0	D-S-A2.0-(2.5)-...-67°	Working distance typ. 20 mm ... 30 mm
KL-D-30°-23-KG2-A2.0	D-S-A2.0-(2.5)-...-67°	Working distance typ. 20 mm ... 30 mm
KL-D-40°-13-A2.0	D-S-A2.0-(2.5)-...-67°	Working distance typ. 15 mm ... 25 mm
KL-D-40°-23-5/DIF-A2.0	D-S-A2.0-(2.5)-...-67°	(to be supplemented)
KL-D-40°-23-5/DIF-A3.0	D-S-A3.0-(3.0)-...-67°	(to be supplemented)
KL-D-45°-14-A2.0	D-S-A2.0-(2.5)-...-67°	(to be supplemented)
KL-D-M12-0°/30°-9-A2.0	D-S-A2.0-(2.5)-...-67°	(to be supplemented)
KL-D-M12-0°/30°-9-A3.0	D-S-A3.0-(3.0)-...-67°	(to be supplemented)
KL-D-M12-XL-0°/30°-30-A2.0	D-S-A2.0-30°/30-A2.0 <i>Special version*</i>	Working distance typ. 10 mm ... 100 mm

*Special version:

Version is different to the standard version (e.g. no standard fiber adapter) and therefore is suitable only for certain sensors or applications



Fiber Optics Fixtures

Mounting brackets (fixtures) for transmitted light fiber optics with sensor head type „A2.0“, „A3.0“, or „R2.1“:

Part number:	Suitable for fiber optics type: (D= transmitted light)	Characteristics:
C-MOUNT-A2.0-180°-22/50	D-S-A2.0-(2.5)-...-67°	Transmitter/receiver distance 22 mm, fork width/depth: 50/50 mm
C-MOUNT-A2.0-180°-60/50	D-S-A2.0-(2.5)-...-67°	Transmitter/receiver distance 22 mm, fork width/depth: 60/50 mm
C-MOUNT-A2.0-180°-100/50	D-S-A2.0-(2.5)-...-67°	Transmitter/receiver distance 100 mm, fork width/depth: 100/50 mm
C-MOUNT-A3.0-180°-16/50	D-S-A3.0-(3.0)-...-67°	Transmitter/receiver distance 16 mm, fork width/depth: 50/50 mm
C-MOUNT-A3.0-180°-60/50	D-S-A3.0-(3.0)-...-67°	Transmitter/receiver distance 60 mm, fork width/depth: 94/50 mm
C-MOUNT-A3.0-180°-100/50	D-S-A3.0-(3.0)-...-67°	Transmitter/receiver distance 100 mm, fork width/depth: 100/50 mm
MOUNT-A2.0-170°-5	D-S-A2.0-(2.5)-...-67°	Angle of incidence 85° to the vertical in a distance of 5 mm to the object, gloss control of extremely rough surfaces
MOUNT-A3.0-170°-5	D-S-A3.0-(3.0)-...-67°	Angle of incidence 85° to the vertical in a distance of 5 mm to the object, gloss control of extremely rough surfaces
MOUNT-A2.0-150°-10	D-S-A2.0-(2.5)-...-67°	Angle of incidence 75° to the vertical in a distance of 10 mm to the object, gloss control of rough surfaces
MOUNT-A3.0-150°-10	D-S-A3.0-(3.0)-...-67°	Angle of incidence 75° to the vertical in a distance of 10 mm to the object, gloss control of rough surfaces
MOUNT-A2.0-120°-12	D-S-A2.0-(2.5)-...-67°	Angle of incidence 60° to the vertical in a distance of 12 mm to the object, gloss control of matt to light glossy surfaces
MOUNT-A3.0-120°-12	D-S-A3.0-(3.0)-...-67°	Angle of incidence 60° to the vertical in a distance of 12 mm to the object, gloss control of matt to light glossy surfaces
MOUNT-R1.1-120°-12	D-S-R1.1-(3x0.5)-...-67°	Angle of incidence 60° to the vertical in a distance of 12 mm to the object, gloss control of matt to light glossy surfaces
MOUNT-R2.1-120°-12	D-S-R2.1-(6x1)-...-67°	Angle of incidence 60° to the vertical in a distance of 12 mm to the object, gloss control of matt to light glossy surfaces
MOUNT-A2.0-90°-15	D-S-A2.0-(2.5)-...-67°	Angle of incidence 45° to the vertical in a distance of 15 mm to the object, gloss control of matt to glossy surfaces
MOUNT-A3.0-90°-15	D-S-A3.0-(3.0)-...-67°	Angle of incidence 45° to the vertical in a distance of 15 mm to the object, gloss control of matt to glossy surfaces
MOUNT-A2.0-40°-20	D-S-A2.0-(2.5)-...-67°	Angle of incidence 20° to the vertical in a distance of 20 mm to the object, gloss control of very glossy surfaces
MOUNT-A3.0-40°-20	D-S-A3.0-(3.0)-...-67°	Angle of incidence 20° to the vertical in a distance of 20 mm to the object, gloss control of very glossy surfaces

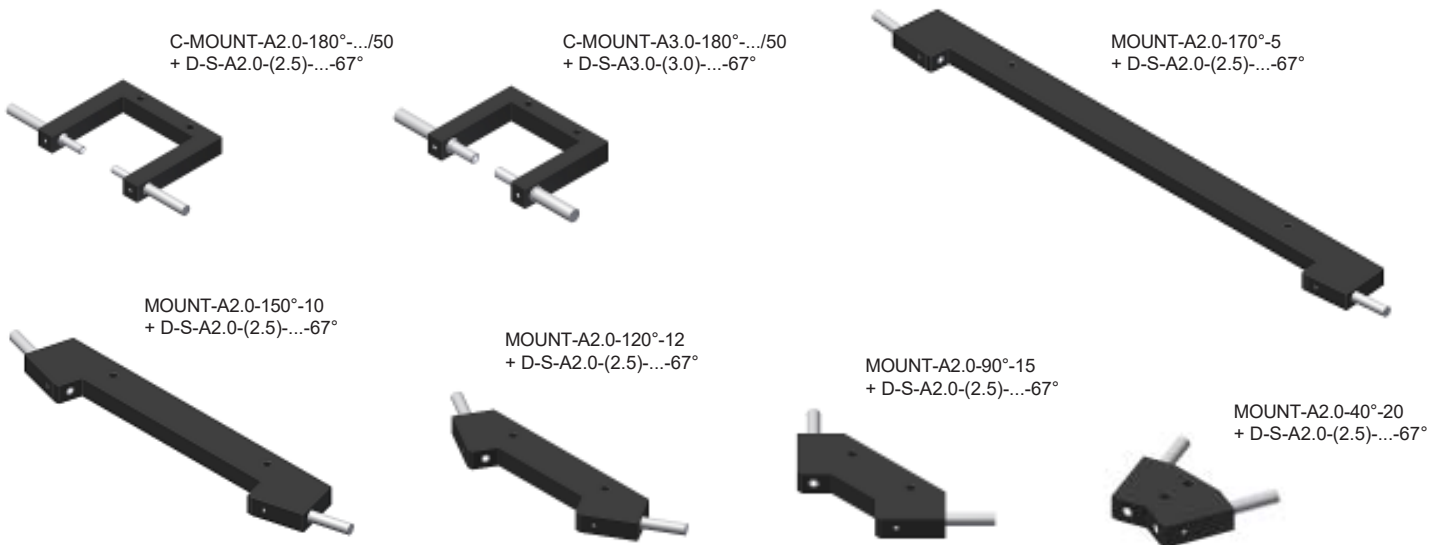



Fiber Optics Fixtures

Mounting brackets (fixtures) for transmitted light fiber optics with sensor head type „Q...“ (cross-section converter):

Part number:	Suitable for fiber optics type:	Characteristics:
	(D= transmitted light)	
C-MOUNT-Q1-180°-50/50	D-S-Q1-(5x0.5)-...-67°	Width of measuring range: 5 mm, transmitter/receiver distance: 50 mm, distance beginning of measurement range (inner side) to inner edge of housing: 50 mm
C-MOUNT-Q2-180°-50/50	D-S-Q2-(10x0.3)-...-67°	Width of measuring range: 10 mm, transmitter/receiver distance: 50 mm, distance beginning of measurement range (inner side) to inner edge of housing: 50 mm
C-MOUNT-Q3-180°-50/50	D-S-Q3-(18x0.3)-...-67°	Width of measuring range: 18 mm, transmitter/receiver distance: 50 mm, distance beginning of measurement range (inner side) to inner edge of housing: 50 mm
C-MOUNT-Q4-180°-50/50	D-S-Q4-(28x0.2)-...-67°	Width of measuring range: 28 mm, transmitter/receiver distance: 50 mm, distance beginning of measurement range (inner side) to inner edge of housing: 50 mm
C-MOUNT-Q5-180°-50/50	D-S-Q5-(38x0.15)-...-67°	Width of measuring range: 38 mm, transmitter/receiver distance: 50 mm, distance beginning of measurement range (inner side) to inner edge of housing: 50 mm
C-MOUNT-Q6-180°-50/50	D-S-Q6-(48x0.15)-...-67°	Width of measuring range: 48 mm, transmitter/receiver distance: 50 mm, distance beginning of measurement range (inner side) to inner edge of housing: 50 mm



C-MOUNT-Q1-180°-50/50
+ D-S-Q1-(5x0.5)-...-67°

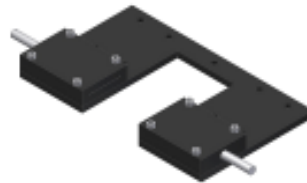

C-MOUNT-Q4-180°-50/50
+ D-S-Q4-(28x0.2)-...-67°

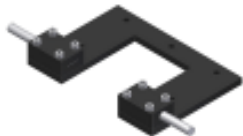

C-MOUNT-Q2-180°-50/50
+ D-S-Q2-(10x0.3)-...-67°

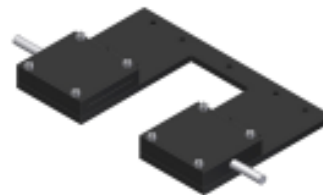

C-MOUNT-Q5-180°-50/50
+ D-S-Q5-(38x0.15)-...-67°

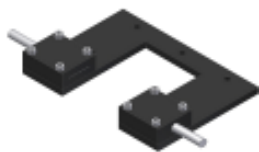

C-MOUNT-Q3-180°-50/50
+ D-S-Q3-(18x0.3)-...-67°

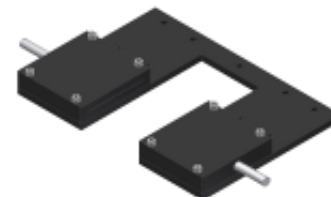

C-MOUNT-Q6-180°-50/50
+ D-S-Q6-(48x0.15)-...-67°