

In Proud Partnership with Sensor Instruments



For technical support, sales, & distribution within the USA & Canada

www.paquin.com | (800) 831-8217 | paquinsensors@paquin.com

# FIA Series

## ▶ FIA-L-S-d0.2-...-RL-TypA-3pol

- Visible red laser light
- Class 1 laser product (680 nm, P<0.39 mW) 
- Integrated electronics
- Various fork sizes available
- Laser beam typ. Ø 0.2 mm
- Insensitive to dirt accumulation, insensitive to outside light
- Optical long-pass filter
- High switching frequency (typ. 50 kHz)
- Switching state indication (yellow LED)
- Scratch-resistant optics
- **3-pole M8-connector (180° rotated compared to the standard version)**
- Sturdy aluminum housing, compact design



### Design

#### Product name:

FIA-L-S-d0.2-(fork size)-(switching output)-RL-TypA-3pol

**Laser beam diameter:**  
d0.2 (Ø 0.2 mm)

- Available fork sizes:** (cf. dimensions page 3)
- 10/30** (fork width A=10 mm, fork depth B=30 mm)
  - 20/30** (fork width A=20 mm, fork depth B=30 mm)
  - 20/40** (fork width A=20 mm, fork depth B=40 mm)
  - 25/50** (fork width A=25 mm, fork depth B=50 mm)
  - 25/80** (fork width A=25 mm, fork depth B=80 mm)
  - 30/30** (fork width A=30 mm, fork depth B=30 mm)
  - 30/40** (fork width A=30 mm, fork depth B=40 mm)
  - 40/30** (fork width A=40 mm, fork depth B=30 mm)
  - 40/40** (fork width A=40 mm, fork depth B=40 mm)
  - 40/60** (fork width A=40 mm, fork depth B=60 mm)
  - 60/60** (fork width A=60 mm, fork depth B=60 mm)

#### Switching output:

- Q** pnp bright-switching / npn dark-switching
- Qinv** pnp dark-switching / npn bright-switching

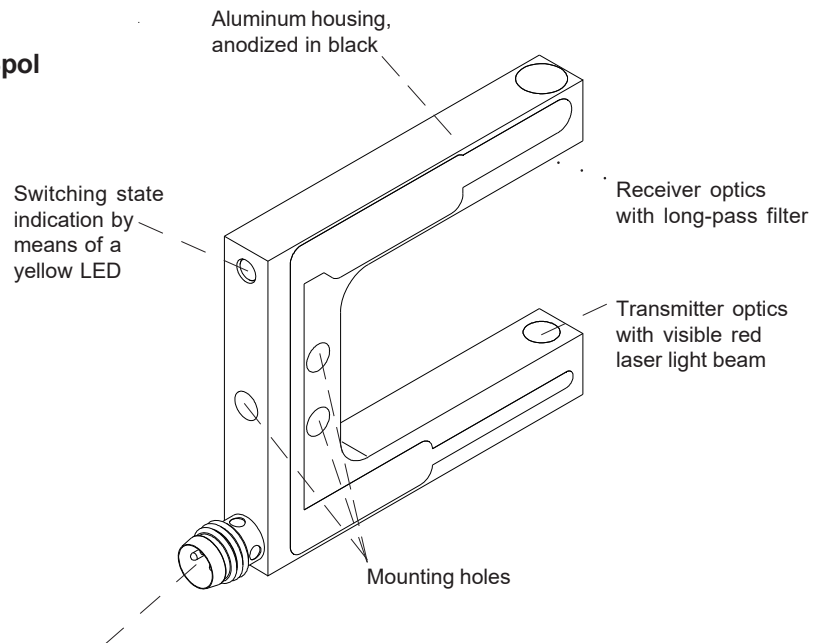

3-pole M8-connector  
(Typ A = 180° rotated compared to standard version)

Connecting cable:  
cab-M8/3-... (cf. page 3)

**Typ A**  
(3-pole M8 connector 180° rotated)

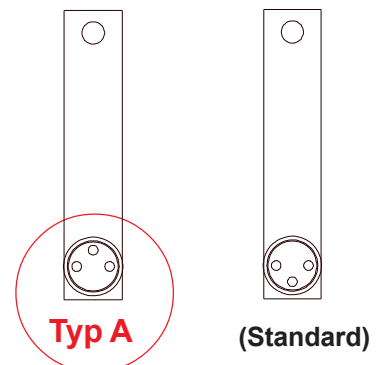



**Technical Data**

Type	FIA-L-S-d0.2-...-RL-TypA-3pol
Light source	Solid state laser 680 nm, DC operation, 0.39 mW max. opt. power, laser class 1 acc. to DIN EN 60825-1. The use of these laser transmitters therefore requires no additional protective measures.
Laser beam	typ. Ø 0.2 mm
Min. detectable object	typ. 0.2 mm
Reproducibility	typ. 5 µm
Optical filter (receiver side)	long-pass filter
Voltage supply	+24VDC (± 10%), reverse polarity protected
Ambient light	up to 5000 Lux
Current consumption	typ. 20 mA
Aperture size (receiver side)	Circular aperture Ø 0.5 mm
Switching output (1x)	either Q or Qinv: Q = pnp bright-switching (pnp n.c.) / npn dark-switching (nnp n.o.) Qinv = pnp dark-switching (pnp n.o.) / npn bright-switching (nnp n.c.) 100mA, short-circuit protection
Enclosure rating	IP67
Operating temperature range	-20°C ... +50°C
Storage temperature range	-20°C ... +85°C
Housing material	Aluminum, anodized in black
Housing dimensions	cf. page 3
Connector type	3-pole M8-connector (metal)
EMC test acc. to	DIN EN 60947-5-2 
Switching frequency	typ. 50 kHz
Switching state indicator	by means of a yellow LED integrated in the sensor housing LED on = sensor free LED off = sensor covered



**Laser Information**

The laser transmitter of FIA-L Series comply with laser class 1 according to EN 60825-1. Under reasonably foreseeable conditions a class 1 laser is safe. The reasonably foreseeable conditions are kept during specified normal operation. The use of these laser transmitters therefore requires no additional protective measures.

The laser transmitter of FIA-L Series are supplied with an information label „CLASS 1 LASER PRODUCT“.

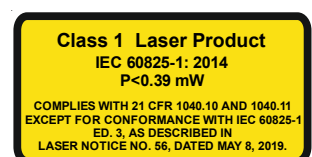

Dimensions

FIA-L-S-d0.2-(fork size)-RL-TypA-3pol:

Fork-size	Dim. A	Dim. B
10/30	10 mm	30 mm
20/30	20 mm	30 mm
20/40	20 mm	40 mm
25/50	25 mm	50 mm
25/80	25 mm	80 mm
30/30	30 mm	30 mm
30/40	30 mm	40 mm
40/30	40 mm	30 mm
40/40	40 mm	40 mm
40/60	40 mm	60 mm
60/60	60 mm	60 mm

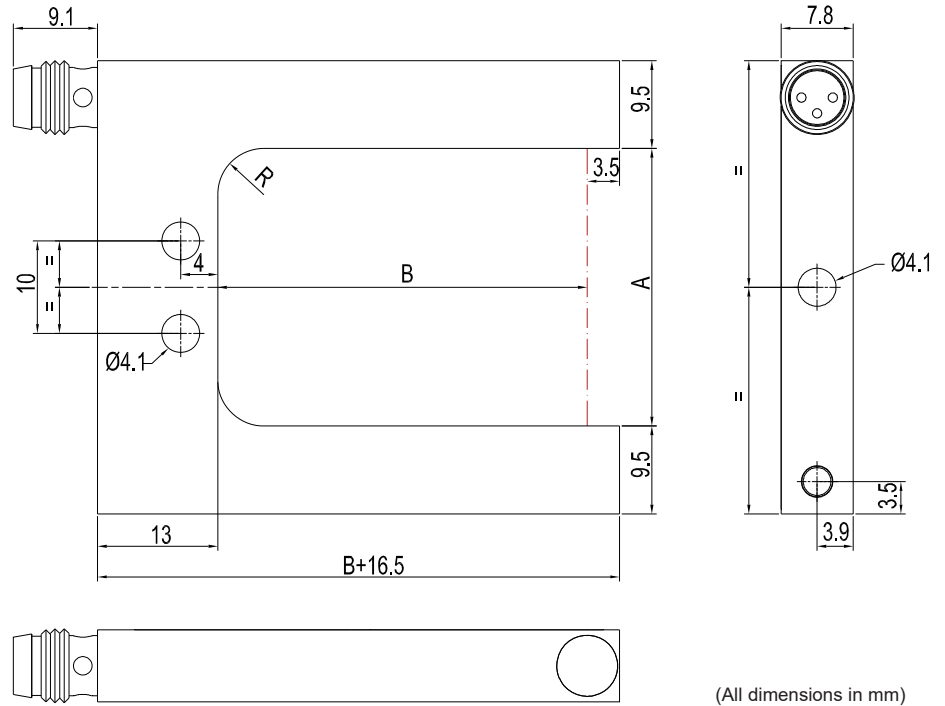

Connector Assignment

FIA-L-S-d0.2-(fork size)-Q-RL-TypA-3pol  
(3-pole M8 connector)

- Pin: Assignment:
- 1 +Ub (+24VDC ± 10%)
  - 3 GND (0V)
  - 4 Q: Output  
(pnp bright-switching / npn dark-switching)

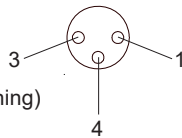

Available connecting cables to PLC:

- cab-M8/3-g-2** (l=2m)
- cab-M8/3-g-5** (l=5m)
- cab-M8/3-w-2** (angle type, l=2m)
- cab-M8/3-w-5** (angle type, l=5m)

FIA-L-S-d0.2-(fork size)-Qinv-RL-TypA-3pol  
(3-pole M8 connector)

- Pin: Assignment:
- 1 +Ub (+24VDC ± 10%)
  - 3 GND (0V)
  - 4 Qinv: Output invers  
(pnp dark-switching / npn bright-switching)

