

Resistance thermometer Pt100 with screw-in thermowell or with flange connection Type Series GA251 .

In Proud Partnership with Labom

PAQUIN
SENSORS

For technical support, sales, & distribution
within the USA & Canada

www.paquin.com | (800) 831-8217 | paquinsensors@paquin.com



Application area

- Chemical and petrochemical industry
- Machinery construction
- General process technology

Features

- Pt100 connection in 3- or 4-wire technology
- Measuring insert 1 x Pt100 or 2 x Pt100
- Measuring insert interchangeable
- Process connection
 - for screw-in
 - with flange connection
- Various thermowell designs available

Options

- Explosion protection
- As per UKCA regulations
- Transmitter can be integrated
- Classification per SIL 2
- Measuring insert for In-process calibration

Application

The resistance thermometer is suited for operation on tanks and pipes. All standard types of process connections are available. The change in resistance, dependent on the measurement temperature, can be detected by a transmitter and converted into a standardized signal. A variety of transmitters for head mounting is available for different applications.

For In-process calibration the integration of a special measuring insert with additional test pipe is possible (data sheet T4-025-45, Type GA3100, reference sensor: data sheet T4-025-46, Type GA3110).

Technical Data

Mechanical design

Measuring insert interchangeable with connection head and neck-tube

Connection head

selective

- model B, cap with 2 slotted screws, mat. aluminium, IP 54
- model BUZH, high spring cover with slotted screw, mat. aluminium, IP 65
- field housing Ø 60 mm, screw cap, stainless steel mat.-no. 1.4305 (303), IP 67 further connection heads upon request

Thermowell

material stainless steel mat.-no. 1.4571 (316Ti). Special materials upon request. Thermowell 9 x 1 bzw. 11 x 2 mm

length see order details

option: certification of material testing per DIN EN 10204

Upon request a calculation for thermowells can be made (for static or dynamic application) with certificate.

Measuring insert

Material stainless steel, interchangeable, DIN 43735

length of measuring insert l_s = thermowell length L + 10 mm

Ø of meas. insert depending on thermowell, standard 6 mm

resistor Pt100 according to EN 60751

Optional: Measuring insert with connection socket per DIN 43735 and with additional test pipe for In-process calibration.

Material: stainless steel, mat.-no. 1.4571 (316 T_i) (see data sheet T4-025-45)

Type of sensor/class/circuit

see order details

Ex-approval

Ex-type examination certificate for

Standard measuring insert:

BVS 04 ATEX E 144 X

⊕ II 2G EEx ia IIC T4/T6

$U_i \leq 30$ V

$P_i \leq 200$ mW

More technical information see XA_002.

Intrinsically safe per EN 60079-11, P5.7 simple electrical apparatus (UK).

More technical information see XA_030.

Measuring insert In-process calibration:

IBExU 13 ATEX 1017 X

⊕ II 2G Ex ia IIC T6...T1 Gb

$U_i \leq 30$ V

$P_i \leq 750$ mW

L_i max. 10 µH/m

C_i max. 500 pF/m

More technical information see XA_003.

Intrinsically safe per EN 60079-11, P5.7 simple electrical apparatus (UK).

More technical information see XA_003.

Functional safety

per EN 61508, classification per SIL2; without transmitter, only

Accuracy of the measuring resistor

class A per EN 60751

For In-process measuring insert: class A in the range -50...300 °C, above this class B

Process connections

for screw-in/insertion/weld-in

- G 1/2 B, G 3/4 B
- G 1 B
- M 20 x 1.5
- 1/2" NPT, 3/4" NPT with flange connection
- DN50 PN10/40 model B1 (DIN EN 1092-1)
- DN25 PN10/40 model B1 (DIN EN 1092-1)

Further process connections upon request material: stainless steel mat. no. 1.4571 (316Ti)

Integration of transmitter

suitable Pt100 transmitters can be integrated into the connection head.

Options:

- instead of terminal block
- mounting in the spring cover of the connection head BUZH see product group T4 for analog or digital transmitters

LED-on-site indication

programmable LED-on-site indication for stainless steel field housing (Ø 60 mm), see data sheet M6-031.

Dimensions

connection heads

model B, cap with
2 slotted screws
mat. aluminium, IP 54

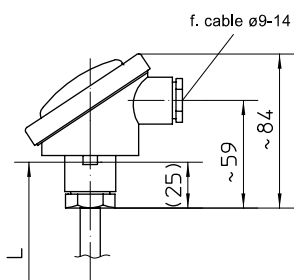

model BUZH, high spring cover
with slotted screw,
mat. aluminium, IP 65

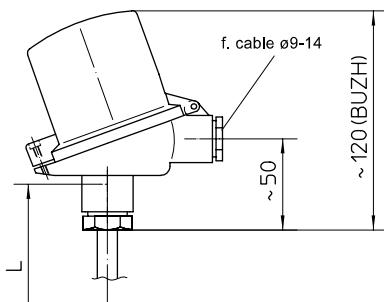

connection head field housing,
screw cap,
mat. stainless steel, IP 67

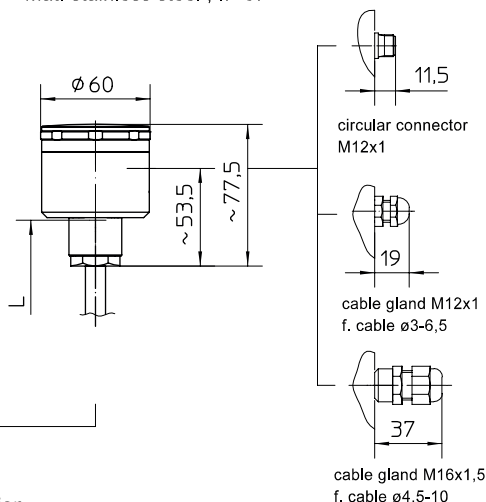

thermowell models

process connection

thermowell according to DIN 43772:

insertion/
welding

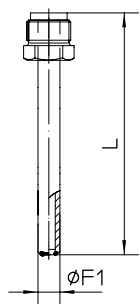

model 2

insertion/
welding

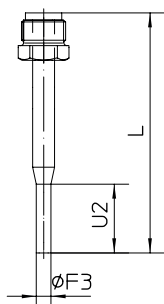

similar model 3
with reduced tip

screw-in

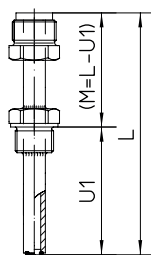

model 2 G/3 G
parallel thread
G1/2B
G3/4B
G1B
M20x1,5

screw-in

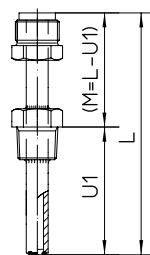

model 2 G/3 G
conical thread
1/2"NPT
3/4"NPT

flanged

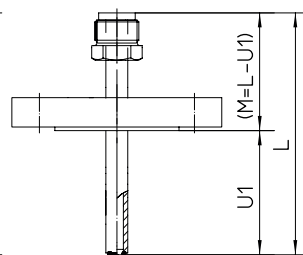

model 2 F/3F
DIN-flange
DN50/PN10/40
model B1 (DIN EN 1092-1)
DN25/PN10/40
model B1 (DIN EN 1092-1)

Connection diagram

connection head

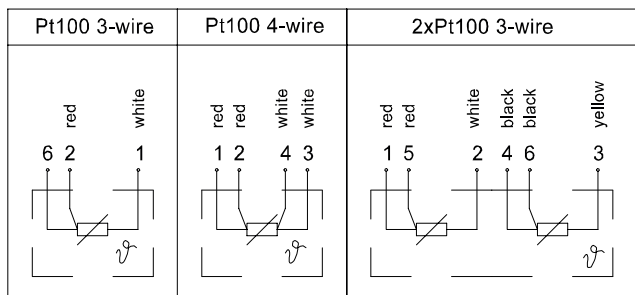

circular connector M12x1

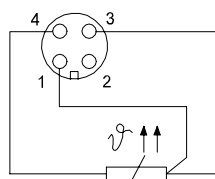

Order details

Resistance Thermometer Pt100 with screw-in thermowell or with flange connection									
design	· with thermowell								GA251
ex-protection	· without								0
	· explosion protection, type of ex-protection s. below								1
process connection	· without, for insertion or for welding								A01
	· G 1/2 B								A10
	· G 3/4 B								A11
	· G 1 B								A12
	· M 20 x 1.5								A13
	· 1/2" NPT								A15
	· 3/4" NPT								A16
	· flange DN25 PN 10/40 model B1 (DIN EN 1092-1)								A21
· flange DN50 PN 10/40 model B1 (DIN EN 1092-1)								A22	
material process conn.	· stainless steel mat.-no. 1.4571 (316Ti)								1
	· varying								9
thermowell length total L	length L	meas. insert L _s							
	95 mm	105 mm							B10
	115 mm	125 mm							B13
	130 mm	140 mm							B16
	180 mm	190 mm							B19
	195 mm	205 mm							B22
	245 mm	255 mm							B28
	265 mm	275 mm							B31
	305 mm	315 mm							B37
	365 mm	375 mm							B40
	395 mm	405 mm							B43
	425 mm	435 mm							B46
	515 mm	525 mm							B49
	545 mm	555 mm							B52
varying								B99	
thermowell Ø and model	· F1 = 9 mm, thermowell 9/7, model 2 per DIN, standard								C12 ...
	· F1 = 11 mm, thermowell 11/7, model 2 per DIN								C13 ...
	· 9/7, reduced tip F3 = Ø 5x20 mm, ID 3.5 mm								C16 ...
	· 12, reduced tip F3 = Ø 9x40 mm, ID 7 mm								C17 ...
	as in writing								C99 ...
thermowell material	stainless steel mat.-no. 1.4571 (316Ti)								1
	varying								9
immersion length U1 ¹	length in mm (e.g. 160 for 160 mm), U _{max} = L - 60 mm								...
	varying, as in writing								999
measuring insert as per DIN 43735 (class A)	diameter, design, material	meas. element		operating range		test pipe			
	· 6 mm, st. steel, standard	thin film		-50...+400 °C		-		D2-M22	
	· 6 mm, sheathed element, st. steel	ceramic		-200...+600 °C		-		D6-M21	
sensor type	· 6 mm, rigid, st. steel (In-process)								D22-M24
	· 1 x Pt100 in 3-wire technology, standard								N2
	· 1 x Pt100 in 4-wire technology								N3
connection head	· 2 x Pt100 in 3-wire technology								N5
	· model B	electrical connection cable gland M20x1.5							T11
		nickel plated brass, cable Ø 9-14							T15
	· model BUZH	cable gland	polyamide black	cable Ø 3-6.5				T47	
				cable Ø 4.5-10				T47.40	
	· field housing	cable gland	st. steel	cable Ø 3-6.5				T47.21	
with circular connector M12x1						T47.51			
· field housing with additional opening for reference sensor	cable gland	polyamide black	cable Ø 3-6.5				T49		
			cable Ø 4.5-10				T49.40		
		st. steel	cable Ø 3-6.5				T49.21		
			cable Ø 4.5-10				T49.21		
additional features (to be indicated in case of need, only)									
type of ex-protection	· Intrinsically safe per EN 60079-11, P5.7 simple electrical apparatus (UK; standard measuring insert)								S52
	· Intrinsically safe per EN 60079-11, P5.7 simple electrical apparatus (UK; Measuring insert In-process calibration)								S53
	· II 2G EEx ia IIC T4/T6 ⁴ , BVS 04 ATEX E 144 X (standard measuring insert)								S68
	· II 2G Ex ia IIC T6...T1 Gb, IBEU 13 ATEX 1017 X (In-process calibration)								S75
incl. transmitter (pls specify separately)	· mounting on the measuring insert (instead of terminal block)							Z1	
	· mounting in the spring cover of the connection head BUZH							Z2	
material certificate per DIN EN 10204-3.1									
functional safety per EN 61508, classification per SIL2									
as per UKCA regulations ⁵									
transmitter with resistance thermometer calibrated, incl. calibration certificate with 3 meas. points									
order code (example):									
GA2510 A101 B37 C121160 D2-M22 N2 T47									

¹ not possible with process connection A01 (insertion/welding)
² up to 300 °C accuracy class A, above this class B
³ for In-process calibration only
⁴ only with sheathed element
⁵ not possible with inline diaphragm seal or connection to inline unit ASEPconnect with pipe diameter > 25 mm