

# Resistance thermometer MiniTherm

## for hygienic process connections

### Type series GA270.HY

In Proud Partnership with Labom

**PAQUIN**  
SENSORS

For technical support, sales, & distribution  
within the USA & Canada

www.paquin.com | (800) 831-8217 | paquinsensors@paquin.com



SIL2



#### Application area

- Pharmaceutical industry
- Food industry
- Biotechnology

#### Features

- Resistance thermometer for invasive temperature measurement in tanks and pipes
- Pt100 directly integrated into a sensor tube
- Compact design
- High measurement accuracy
- Various hygienic process connections
- Connections per DIN 11851, VARIVENT® and Clamp per DIN 32676 / ISO 2852 with EHEDG certificate
- Fast response
- Measuring resistor Pt100 or 2 x Pt100, class A
- Circular connector M12

#### Options

- Approvals/Certificates
  - Ex-Schutz (ATEX/CCCEX)
  - Classification per SIL2
  - Material certificate per EN 10204-3.1
  - Calibration certificate per EN 10204-3.1
- As per UKCA regulations
- Output signal 4...20 mA via transmitter PA2430
- Output signal IO-Link V1.1 via transmitter PA2530
- Sensor tube with reduced tip Ø 4 mm
- Wetted parts electropolished

#### Application

The resistance thermometer MiniTherm is suited for temperature measuring in tanks and pipes especially in hygienic applications. The change in resistance, dependent on the measurement temperature, can be detected and converted by a transmitter. Because of its compact design and high accuracy MiniTherm is suitable for use in a great number of technological processes.

## Technical data

### Constructional design

Design:	Pt100 directly integrated into a sensor tube, various types of process connections are available
Electrical connection:	Circular connector M12 (4-pin) Option: Circular connector M12 (8-pin) for 2 x Pt100
	Further electrical connections upon request.
Working pressure:	max. 16 bar (excluded VARIVENT®, Form N with max. 10 bar)

### Measuring insert

Design:	Sensor tube Ø 6 mm Option: Sensor tube with reduced tip Ø 4 mm Length see order code.
Measuring resistor:	<ul style="list-style-type: none"><li>■ Pt100 per EN 60751, class A 3-wire</li><li>■ Pt100 per EN 60751, class A 4-wire (3-wire bridged)</li><li>■ 2 x Pt100 per EN 60751, class A 3-wire</li></ul>
Degree of protection:	IP 67 per EN 60529

### Output signal transmitter

#### Output signal 4...20 mA :

Detailed informations about transmitter type PA2430 see product page on [www.labom.com](http://www.labom.com).

#### Output signal IO-Link V1.1:

Detailed informations about transmitter type PA2430 see product page on [www.labom.com](http://www.labom.com).

### Process connection

Design:	See order code
---------	----------------

Sealing are not included in the scope of delivery.

### Material wetted parts

Material:	Stainless steel mat.-no. 1.4404 (316L)
-----------	--

### Hygienic design

The wetted surfaces made of stainless steel are executed according to EHEDG Doc.8 and ASME BPE SF3. We guarantee the following surface roughness values:

Laser welds:	$Ra \leq 0,76 \mu\text{m}$
Turned parts:	$Ra \leq 0,76 \mu\text{m}$

Further versions of hygienic design upon request.

### Accuracy

Pt100:	Per EN 60751, class A
Response time:	Per EN 60751, test procedure with flowing water (without transmitter) Sensor tube Ø 6 mm: $T_{90} = 5.5 \text{ s}$  Sensor tube with reduced tip Ø 4 mm: $T_{90} = 4.5 \text{ s}$

### Temperature ranges

Ambient: <sup>1</sup>	-40...85 °C
Media:	-50...200 °C
Storage: <sup>1</sup>	-40...85 °C

<sup>1</sup> Different temperature ranges for devices with transmitter (see data sheets for the types PA2430 or PA2530).

### Messumformer

Installation variants:	<ul style="list-style-type: none"><li>■ Transmitter, Type PA2430, for circular connector M12</li><li>■ Transmitter, Type PA2530 IO-Link, for circular connector M12</li></ul>
------------------------	---

### Tests and certificates

#### Ex approval

ATEX:	TÜV 08 ATEX 554093 X ⊕ II 1G Ex ia IIC T6/T5/T4 ⊕ II 2G Ex ib IIC T6/T5/T4 ⊕ II 1D Ex iaD 20 T89 °C ⊕ II 2D Ex ibD 21 T129 °C $U_i \leq 30 \text{ V}$ $P_i \leq 200 \text{ mW}$ Ci and Li are negligible small (not for devices with transmitter)
CCCEX:	CCCEX No. 2022322315004603 Ex ia IIC T6...T4 Ga Ex ib IIC T6...T4 Gb Ex ia IIIC T89 °C Da Ex ib IIIC T129 °C Db
UK:	Intrinsically safe per EN 60079-11, P5.7 simple electrical apparatus

Further technical data see Ex Instructions XA\_001 (ATEX) and XA\_029 (CCCEX).

SIL2:	Functional safety: per EN 61508, classification of Pt100 sensor per SIL2, suitable transmitter upon request
-------	--

# Connection diagram

## Circular connector M12

1 x Pt100, 3-wire

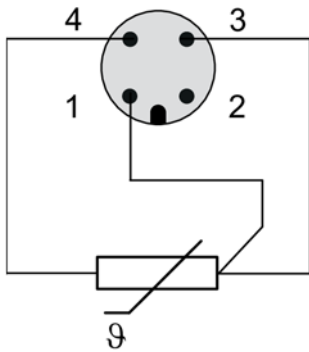

1 x Pt100, 4-wire  
(3-wire bridged)

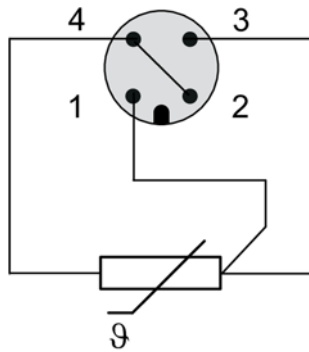

2 x Pt100, 3-wire

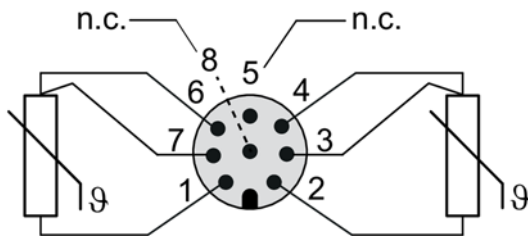

Transmitter  
(type series PA2430)

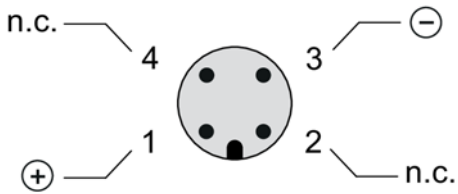

Transmitter IO-Link  
(type series PA2530)

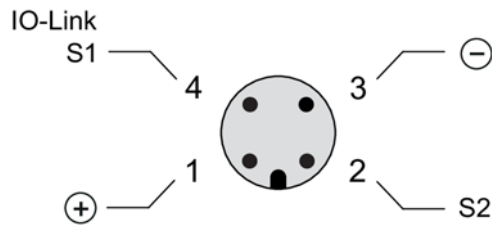

# Dimensions

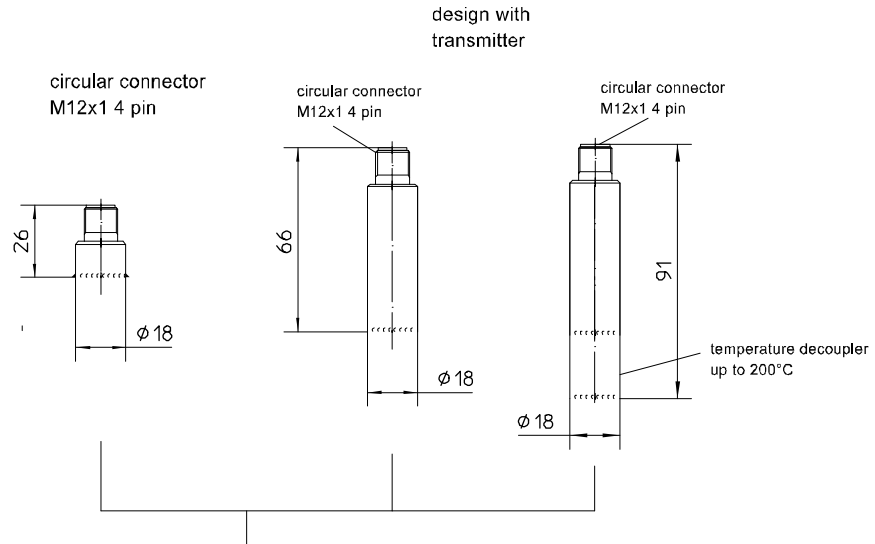

Process connection  
diagramed with circular connector M12x1

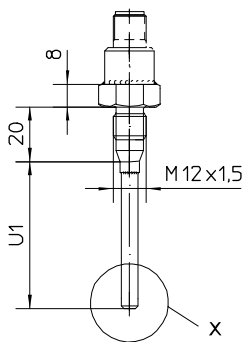

M12x1,5 dead-zone free  
(conical taper of metal)  
tightening torque: 20 Nm

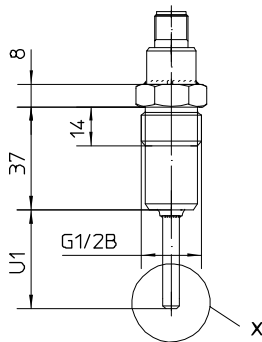

G1/2B dead-zone free  
(conical taper of metal)  
tightening torque: 50 Nm

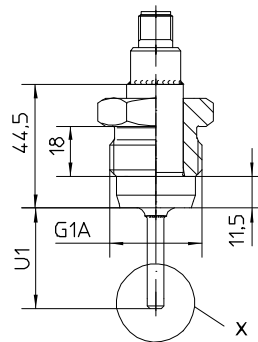

G1A dead-zone free  
(conical taper of metal)  
tightening torque: 20 Nm

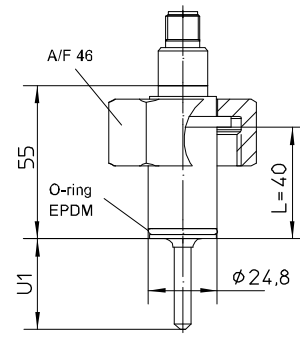

connection per INGOLD  
DN 25 with coupling nut

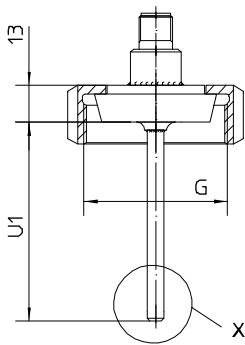

tapered coupling with  
groove union nut DIN 11851  
DN25 G=Rd.52x1/6  
DN32 G=Rd.58x1/6  
DN40 G=Rd.65x1/6

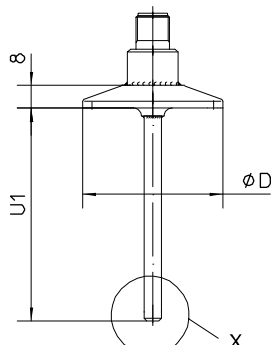

clamp connection  
Tri-Clamp 1/2"/3/4" D=25  
Tri-Clamp 1"/1 1/2" D=50,5  
ISO 2852 DN25/38 D=50,5  
DIN 32676 DN25/40 D=50,5

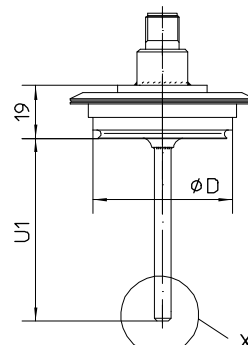

Varivent connection  
D=31 for Varivent-case DN10/DN15  
D=50 for Varivent-case DN25/1"  
D=68 for Varivent-case  
DN 40-125 /1 1/2"...6"

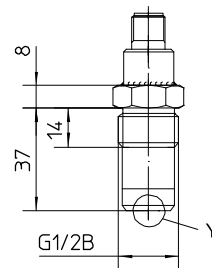

G1/2B dead-zone free  
(conical taper)  
design flush mounted  
tightening torque: 50 Nm

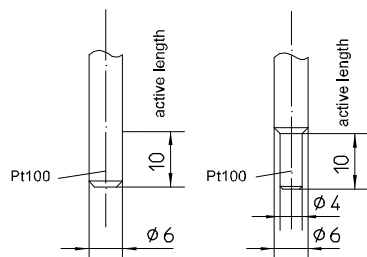

design of stem X

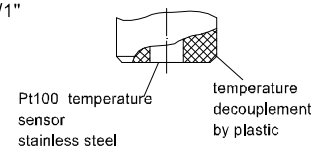

design flush mounted Y

## Order details

Resistance thermometer MiniTherm			
GA270 . HY	Resistance thermometer MiniTherm		
0	design	standard	
1		Ex protection, design see below	
A1011	process connection	threaded connection	G1/2 conical sealing <sup>1</sup>
A1015			G1 A conical sealing <sup>1</sup>
A1031			M12x1.5, conical sealing
A1213		coupling nut per DIN 11851 <sup>2,3</sup>	DN 25
A1214			DN 32
A1215			DN 40
A1413		Clamp per DIN 32676 <sup>2,3,4</sup>	DN 25/40, Ø 50.5 mm
A1423		Clamp per ISO 2852 <sup>2,3,4</sup>	DN 25/38 (1" / 1 1/2"), Ø 50.5 mm
A1424			DN 40/51, Ø 64 mm
A1432		Tri Clamp <sup>4</sup>	1/2" / 3/4", Ø 25 mm
A1433			1" / 1 1/2", Ø 50.5 mm <sup>2,3</sup>
A1510		VARIVENT® connection <sup>2,3</sup>	Form B (D=31) for VARINLINE® access unit
A1511			Form F (D=50) für VARINLINE® access unit
A1512			Form N (D=68) für VARINLINE® access unit
A1810		connection per INGOLD	DN 25, hexagon union nut A/F 46, G1 1/4", L = 40 mm, incl. gasket EPDM (FDA compliant)
C1000		temperature detecting element	flush mounted <sup>5,6</sup>
C1 ...	Ø 6 mm <sup>7</sup>		
C4 ...	Ø 6 mm, reduced design to Ø 4 mm <sup>8,9</sup>		
015	insertion length U1	15 mm <sup>10</sup>	
025		25 mm	
030		30 mm	
035		35 mm	
050		50 mm	
100		100 mm	
150		150 mm	
200		200 mm	
990		as in writing <sup>10</sup>	
G11	material	wetted parts stainless steel mat.-no. 1.4404 (316L) <sup>11</sup>	
G15		wetted parts stainless steel mat.-no. 1.4404 (316L), PEEK, FDA compliant <sup>12</sup>	
N2	measuring insert	Pt100, 3-wire	
N3		Pt100, 4-wire (3-wire bridged) <sup>13</sup>	
N5		2 x Pt100, 3-wire <sup>9,14</sup>	
T150	electrical connections	circular connector M12x1 (4-pin), IP 67	
T151		circular connector M12x1 (8-pin), IP 67 <sup>15</sup>	

Additional features (to be indicated in case of need, only)				
S71	Ex-marking	ATEX	II 1G Ex ia IIC T6 /T5/T4 Ga	
S72			II 2G Ex ib IIC T6 /T5/T4 Gb	
S73			II 1D Ex ia IIIC T89 °C Da	
S74			II 2D Ex ib IIIC T129 °C Db	
S100		CCCEX	Ex ia IIC T6...T4 Ga	
S101			Ex ib IIC T6...T4 Gb	
S102			Ex ia IIIC T89 °C Da	
S103			Ex ib IIIC T129 °C Db	
S52		Intrinsically safe per EN 60079-11, P5.7 simple electrical apparatus (UK)		
W1020		material certificate	per EN 10204-3.1, wetted parts	
W1201	calibration certificate	per EN 10204-3.1, 5 measuring points		
W2604	functional safety per EN 61508, classification per SIL2			
W2660	as per UKCA regulations <sup>16</sup>			
Z52	transmitter with output signal 4...20 mA <sup>14,17,18</sup>	for media temperatures up to 160 °C, transmitter type PA2430		
Z53		with temperature decoupler for media temperatures up to 200 °C, transmitter type PA2430		
Z54	transmitter with output signal IO-Link V1.1 <sup>14,17,18</sup>	for media temperatures up to 160 °C, transmitter type PA2530		
Z55		with temperature decoupler for media temperatures up to 200 °C, transmitter type PA2530		

**Order code (example): GA270. - HY - A1011 - C1050 - G11 - N2 - T150 ...**

- <sup>1</sup> suitable weld-in sockets see product group T6
- <sup>2</sup> EHEDG certified only in connection with hygienic design (order code option HY)
- <sup>3</sup> EHEDG certificate valid only if gaskets are used that are listed in the "EHEDG position paper"
- <sup>4</sup> a temperature decoupler is always used for an installation length  $\leq 25$  mm and in combination with PA2430 / PA2530
- <sup>5</sup> for G1/2 conical only, an additional gasket is not necessary
- <sup>6</sup> higher measurement deviations than class A at media temperatures  $> 90$  °C
- <sup>7</sup> minimum insertion length required U1 = 15 mm
- <sup>8</sup> minimum insertion length required U1 = 17 mm
- <sup>9</sup> when selecting 2 x Pt100 3-L in combination with insertion lengths U1  $< 40$  mm, higher measurement deviations than class A must be expected
- <sup>10</sup> reduced design ( $\varnothing 4$  mm) possible from insertion length U1  $\geq 20$  mm
- <sup>11</sup> not for flush mounted temperature detecting element (C1000)
- <sup>12</sup> for flush mounted temperature detecting element (C1000), only
- <sup>13</sup> not possible in combination with transmitter type PA2xxx (order code Z52, Z53, Z54 and Z55)
- <sup>14</sup> not for devices with Ex-protection
- <sup>15</sup> necessary for measuring resistor 2 x Pt100 (order code N5)
- <sup>16</sup> not possible with thermowell systems with inside pipe diameter  $> 25$  mm
- <sup>17</sup> not for devices with classification per SIL2
- <sup>18</sup> not possible with circular connector M12x1, 8-pin (order code T151)