

Pressure transmitter UNIVERSAL CA

for diaphragm seal operation

Type series CA2110

In Proud Partnership with Labom

PAQUIN
SENSORS

For technical support, sales, & distribution
within the USA & Canada

www.paquin.com | (800) 831-8217 | paquinsensors@paquin.com



Application area

- Pharmaceutical industry
- Food industry
- Biotechnology

Features

- Universal pressure transmitter, hygienic design per EHEDG, FDA and GMP
- Stainless steel case, degree of protection IP 65
- Direct ventilated sensor element
- Measuring range
 - 0...100 mbar to 0...40 bar rel.
 - 0...1 bar to 0...6 bar abs.
- Accuracy $\leq 0,2\%$
- Output signal 4...20 mA, 2-wire technology
- Easy zero setting by using a magnet
- Various process connections with flush mounted diaphragm, selected connections with EHEDG certificate

Options

- Approvals/Certificates
 - Material certificate as per EN 10204-3.1
 - Calibration certificate as per EN 10204-3.1
 - Roughness height rating with inspection certificate acc. to EN 10204-3.1
- As per UKCA regulations
- Wetted parts electropolished
- Degree of protection IP 67
- Hygienic design

Application

The pressure transmitter UNIVERSAL CA is suited for measuring gauge pressure and absolute pressure of gases, vapors and liquids, especially for hygienic applications.

Technical data

Constructional design / case

Design:	Hygienic case design Excellent moisture protection Fully encapsulated electronics unit
Material:	Stainless steel mat.-no. 1.4301 (304)
Degree of protection per EN 60529:	■ IP 65 ■ Optional IP 67
Pressure compensation:	Aeration via sintered filter
El. connection:	■ Circular connector M12x1 ■ Right angle plug EN 175301-803-A (DIN 43650 model A) others upon request
Climatic category:	4K4H per EN 60721 3-4

Process connection

Design:	See order details
---------	-------------------

Hygienic design

The surface roughness of the wetted parts made of stainless steel are executed according to EHEDG Doc.8 and ASME BPE SF3.

In case of choosing the additional feature HY, we guarantee the following surface roughness values:

Diaphragm foil:	$Ra \leq 0.38 \mu\text{m}$
Laser welds:	$Ra \leq 0.76 \mu\text{m}$
Turned parts:	$Ra \leq 0.76 \mu\text{m}$

Further versions of hygienic design upon request.

Measuring system

Sensor:	Piezoresistive measuring element
System filling:	Synthetic oil FD1, free of silicone, FDA compliant

Measuring ranges / overload limits

Measuring range / overload limit:	See order details
Vakuum tightness:	Long term vacuum measurements at relative measurement ranges can alter the device characteristics. (piezoresistive measuring system, only)

Zero settings

Zero point:	Easy zero setting max. $\pm 20 \%$.
-------------	--------------------------------------

Accuracy

Limit point setting:	per DIN 16086
Accuracy (Lin./Hyst./Repr.):	0.2 % v. of mr (mr ≥ 250 mbar) 0.5 mbar (mr < 250 mbar)
Long-term drift:	$\leq 0.1 \%$ / year per EN 61298-1
Temperature influence:	<u>Range:</u> 0...50 °C: $\leq 0.25 \%$ of mr (mr ≥ 400 mbar) $\leq 0.4 \%$ of mr (mr < 400 mbar) $\leq 0.5 \%$ of mr (mr < 160 mbar) <u>Range:</u> -20...0 and 50...85 °C: $\leq 0.4 \%$ of mr (mr ≥ 400 mbar) $\leq 0.6 \%$ of mr (mr < 400 mbar) $\leq 0.8 \%$ of mr (mr < 160 mbar) mr = measuring range

Process connection:

(zero error)

3/4"	10 mbar/10K
DN 25/1"	4.8 mbar/10K
DN 32/1 1/2"	2.3 mbar/10K
DN 40	1.6 mbar/10K
DN 50/2"	0.6 mbar/10K

Output

Signal:	4...20 mA in 2-wire technology
Sampling rate:	10 measurement/second
Current range:	3.8...20.8 mA
Resolution:	2 μA
Current limitation:	≤ 22 mA
Alarm state:	< 3.6 mA
Load, R:	$R \leq (U-9V)/0.02 \text{ A } [\Omega]$ U = supply voltage

Supply voltage

Function range:	9...30 V DC
-----------------	-------------

Temperature ranges

Ambient:	-20...85 °C
Medium:	-20...125 °C, short term 140 °C, optional up to 160 °C for 1 h. Higher process temperatures upon request
Storage:	-40...85 °C

Tests and certificates

EMC:	EMC directives 2014/30/EU
------	---------------------------

Mounting information

Mounting position:	At choice
Calibration position:	Vertical

Connection diagram

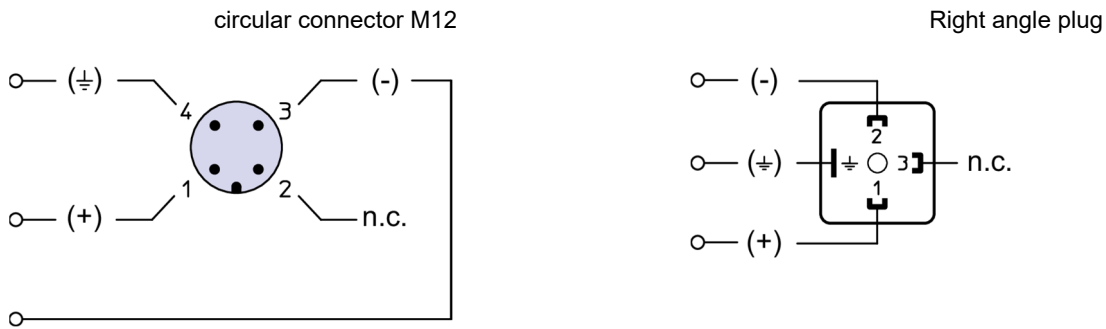

Dimensions

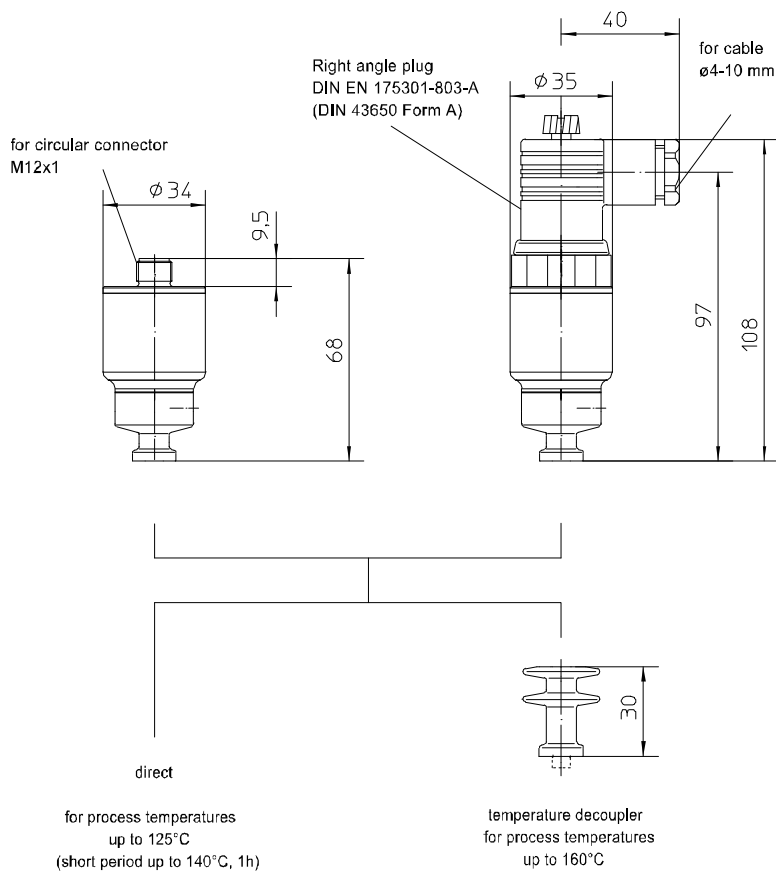

All dimensions are in mm

Process connection

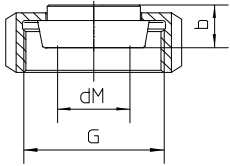

sanitary connection
with coupling nut
per DIN 11851

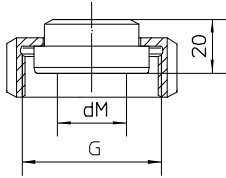

aseptic screw joint
collar connection
with union nut per
DIN 11864-1

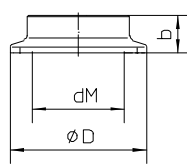

clamp connection
per DIN 32676/ISO 2852

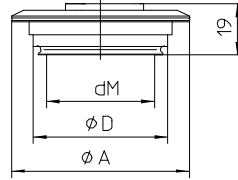

VARIVENT® connection for
VARINLINE® case

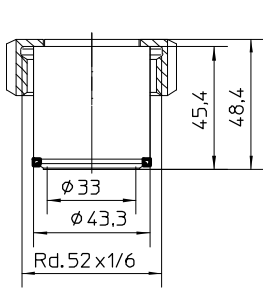

HYGENIC-Tubus *
Ø43.3 with screwing
DN25/PN40

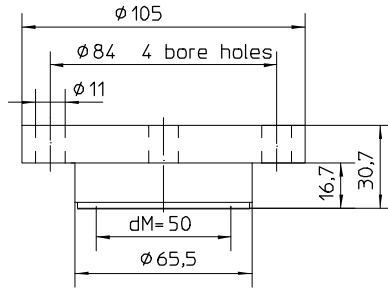

DRD-connection DN50 PN40 *

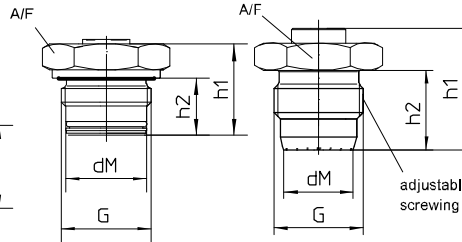

Screw-in thread *
with o-ring-gasket
and additionally gasket
per DIN EN ISO 1179-2
model E (DIN 3852)

HYGENIC-screw-in thread *
no gasket
tightening torque
20 Nm, max. nominal pressure 10 bar
50 Nm, max. nominal pressure 50 bar

* weld-in adapter
see data-sheet D8-037

All dimensions are in mm

Sanitary pipe connection with union nut per DIN 11851

DN	PN	dM	b	G
25	40	27	16	Rd.52x1/6"
32	40	34	16	Rd.58x1/6"
40	40	40	16	Rd.65x1/6"
50	25	51	17	Rd.78x1/6"

Aseptic screw joint collar connection with union nut per DIN 11864-1

DN	PN	dM	G
25	40	24	Rd.52x1/6"
32	40	30	Rd.58x1/6"
40	40	34	Rd.65x1/6"
50	25	48	Rd.78x1/6"

Clamp connection per DIN 32676 model A (metric) for pipes per EN 10357 (DIN 11850)

DN	PN	dM	b	D
25	25	22.6	14	50.5
32	25	27	12	50.5
40	25	34	12	50.5
50	16	46	14	64

Clamp connection per DIN 32676 model B (OD, ISO) for pipes per DIN EN ISO 1127

DN	PN	dM	b	D
26.9	25	22.6	14	50.5
33.7	25	27	12	50.5
42.4	25	34	12	64
48.3	16	40	14	64

Clamp connection per DIN 32676 model C (Tri-Clamp) for pipes per ASME BPE

DN	PN	dM	b	D
3/4"	25	15.5	15	25
1"	25	22.6	14	50.5
1 1/2"	25	34	12	50.5
2"	16	46	14	64

Clamp connection per ISO 2852 for pipes per ISO 2037

DN	PN	dM	b	D
25	16	22.6	14	50.5
38	16	34	12	50.5
51	16	46	14	64

VARIVENT® connection for VARINLINE® access unit

Connection	PN	dM	A	D
Form F	25	40	66	50
Form N	25	58	84	68

HYGIENIC screw-in thread, gasket without elastomer

G	PN (bar)	dM	h1	h2	SW
G1 A	50	24	45	28.5	36

Screw-in thread with O ring gasket

G	PN (bar)	dM	h1	h2	SW
G1/2 A	200	15.5	33	20.5	27
G1 A	50	24	33	20.5	41

Order details

Pressure transmitter Universal CA for diaphragm seal operation			
CA2110	Pressure transmitter UNIVERSAL CA for diaphragm seal operation		
		measuring range	overload limit (bar)
A1008	measuring ranges	0...100 mbar	1
A1009		0...160 mbar	1
A1010		0...250 mbar	3
A1011		0...400 mbar	3
A1012		0...600 mbar	3
A1053		0...1 bar	10
A1054		0...1.6 bar	10
A1055		0...2.5 bar	10
A1056		0...4 bar	20
A1057		0...6 bar	20
A1058		0...10 bar	100
A1059		0...16 bar	100
A1060		0...25 bar	100
A1061		0...40 bar	100
A1025		-100...0 bar	1
A1026		-160...0 bar	1
A1027		-250...0 bar	3
A1028		-400...0 bar	3
A1552		-600...0 bar	3
A1086		-1...0 bar	10
A1087		-1...0.6 bar	10
A1088		-1...1.5 bar	10
A1089		-1...3 bar	20
A1090		-1...5 bar	20
A1091		-1...9 bar	100
A1092		-1...15 bar	100
A1093		-1...24 bar	100
B1053		0...1 bar abs	10
B1054		0...1.6 bar abs	10
B1055		0...2.5 bar abs	10
B1056	0...4 bar abs	20	
B1057	0...6 bar abs	20	
A9999	variants as in writing		
H11	output signal	4...20 mA, 2-wire technology	
T30	electrical connection	circular connector M12	
T51		right angle plug, DIN EN 175301-803-A (DIN 43650 model A) ¹	
T99		others upon request	

Continuation order code			
K1085	design	standard	
K2085		with temperature decoupler	
K102	process connection material: ASTM 316L ²	sanitary pipe connection with union nut per DIN 11851 ^{3,4}	DN 25
K103			DN 32
K104			DN 40
K105			DN 50
K162			DN 25
K163		DN 32	
K165		DN 40	
K166		DN 50	
K124		clamp connection per ISO 2852 for pipes per ISO 2037 ^{3,4}	DN 25 (1")
K126			DN 38 (1 1/2")
K127			DN 51 (2")
K144		clamp connection per DIN 32676, model A (metric) for pipes per EN 10357 (DIN 11850) ^{3,4}	DN 25
K146			DN 32
K147			DN 40
K148			DN 50
K213			DN 26,9
K214		clamp connection per DIN 32676, model B (OD, ISO) for pipes per DIN EN ISO 1127 ^{3,4}	DN 33,7
K215			DN 42,4
K216			DN 48,3
K134		clamp connection per DIN 32676, model C (Tri-Clamp) for pipes per ASME BPE ^{3,4}	DN 3/4" ⁵
K136			DN 1"
K137			DN 1 1/2"
K138			DN 2"
K152		VARIVENT® connection ^{3,4}	Form F (D=50) for VARINLINE® access unit
K153			Form N (D=68) for VARINLINE® access unit
K172		HYGIENIC Tubus	Ø 43,3 mm with screwing DN 25/PN 40
K185		DRD connection	nominal width DN 50 / nominal pressure PN 40
K195		screw-in thread	G 1 A with O-ring seal ⁶
K80	G 1 A with hygienic process connection (elastomer-free)		
	surface roughness	standard	
HY	(wetted parts)	Hygienic version as per EHEDG Doc.8 and ASME BPE SF3	

Additional features (to be indicated if required)	
T1	degree of protection IP 67 ⁷
W1020	material certificate per DIN EN 10204-3.1, wetted parts (stainless steel)
W2660	As per UKCA regulations

Order code (example): CA2110 - A1009 - H11 - K2085 - K214 - HY - ...

¹ not in degree of protection IP 67

² further process connections upon request

³ EHEDG certified only in connection with hygienic design (order code option HY)

⁴ EHEDG certificate valid only if gaskets are used that are listed in the "EHEDG position paper"

⁵ possible for measuring ranges ≥ 250 mbar. For a function calculation and optimim system design it is necessary to specify the operation temperature

⁶ hygienic design not available

⁷ only with circular connector