

## Pressure transmitter PASCAL Ci4 for diaphragm seal operation, hygienic Type series CI411.

In Proud Partnership with Labom

# PAQUIN SENSORS

For technical support, sales, & distribution  
within the USA & Canada

www.paquin.com | (800) 831-8217 | paquinsensors@paquin.com



### Application area

- Pharmaceutical industry
- Food industry
- Biotechnology

### Application

The digital pressure transmitter PASCAL Ci4 is suitable for measuring the relative and absolute pressure of gases, vapors and liquids. Due to the design and various process connections the transmitter is suitable for the hygienic requirements of the food and pharmaceutical industry.

### Features

- Pressure transmitter for the measuring of relative and absolute pressures of gases, vapors and liquids in applications for food and pharmaceutical industry
- Stainless steel case in hygienic design, degree of protection IP 65/67
- Accuracy  $\leq 0.1\%$
- High-resolution graphic display with Intuitive 4-button operation and backlight
- Comprehensive parameterising functions
- Comprehensive simulation and diagnostic functions
- Quick access to device data
- Development according to SIL2
- Nominal range 0.25 bar to 40 bar
- Turndown up to 100:1
- Measuring rate up to 100 Hz
- Output signal 4...20 mA with HART® protocol
- Configuration memory
- Digital communication via PDM, FDT/DTM, 375/475 Field Communicator
- Output functions: linear, invers, square root, table function with up to 64 support points
- Media temperature up to 160 °C
- Wetted parts stainless steel
- Case design:
  - process connection bottom
  - process connection back
- Various hygienic process connections, selected connections with EHEDG certificate
- Approved according to NAMUR 95

### Options

- Labom REconnect quick coupling device for easy and safe separation and connection of diaphragm seal systems; Type series MK1000, see data sheet DB\_D6-022
- Accuracy  $\leq 0.075\%$
- Approvals/Certificates
  - Explosion protection (ATEX/IECEX/UKEX) for gases and dust
  - Classification per SIL2
  - Material certificate per EN 10204-3.1
  - Calibration certificate per EN 10204-3.1
- As per UKCA regulations
- Active temperature compensation (ATC technology)
- Operating software LAB4Level for level measurements
- Removable display and control unit
- Degree of protection IP 69K
- Wetted parts electropolished

## Technical data

### Measuring ranges

Up to a turndown of 100:1 the measuring span can be freely selected

Nominal range	Measuring span		Overload capacity	Higher overload (option)	Sensor type
	min	max			
0...1 bar *	0,01 bar	2 bar	3 bar	-	Piezoresistive
0...4 bar *	0,04 bar	5 bar	10 bar	-	
0...16 bar *	0,16 bar	17 bar	60 bar	-	
0...40 bar *	0,4 bar	41 bar	100 bar	-	
-0,25...0,25 bar	0,0025 bar	0,5 bar	1 bar	6 bar	
-1...1 bar	0,01 bar	2 bar	3 bar	10 bar	
-1...4 bar	0,04 bar	5 bar	10 bar	25 bar	
-1...16 bar	0,16 bar	17 bar	60 bar	120 bar	
-1...40 bar	0,4 bar	41 bar	100 bar	120 bar	
0...1 bar abs	0,01 bar abs.	1 bar abs.	3 bar abs.	-	
0...4 bar abs	0,04 bar abs.	4 bar abs.	10 bar abs.	-	
0...16 bar abs	0,16 bar abs.	16 bar abs.	60 bar abs.	-	
0...40 bar abs	0,4 bar abs	40 bar abs	120 bar abs	-	

\* Short term or sporadic measurement in vacuum range permitted up to lower measuring limit. Lower range value up to -1 bar rel. adjustable.

\*\* Vacuum-proof designs are available upon request.

### Constructional design / case

Design: Two-chamber case, continuously rotatable by  $\pm 170^\circ$   
Case surface blasted

Material case:   

- Stainless steel mat.no. 1.4301/1.4305 (304/303)
- Stainless steel mat.no. 1.4404 (316L)

Material front cover:   

- Stainless steel mat.no. 1.4305 (303)
- Stainless steel mat.no. 1.4404 (316L)
- Polypropylene, black

Gaskets: Silicone / NBR

Degree of protection per EN 60529: IP 65 / IP 67  
Option: IP 69K

Climatic category: 4K4H per EN 60721 3-4

Vibration resistance per EN 61298-3: 10...60 Hz:  $\pm 0.35$  mm  
60...1000 Hz: 5 g

Material window:   

- Macrolon
- Non-splintering glass (requires front cover of stainless steel)

Elec. connection:   

- Circular connector M12
- Cable gland M16x1.5, PA black
- Cable gland M16x1.5, stainless steel
- Cable gland M20x1.5, PA black
- Cable gland M20x1.5, stainless steel
- 1/2" NPT, PA black

Further connections upon request

Terminal blocks:

- Spring clamp terminals up to 1.5 mm<sup>2</sup>
- Pole terminals up to 2.5 mm<sup>2</sup>
- Screw terminals up to 2.5 mm<sup>2</sup>

Weight:

approx. 1.4 kg (without diaphragm seal)

Type plate:

Laser marking

### Process connection

Position:

- bottom
- back

Design:

See order details

### Material wetted parts

Material:

See order details

### Hygienic design

The surface roughness of the wetted parts made of stainless steel are executed according to EHEDG Doc.8 and ASME BPE SF3.

In case of choosing the additional feature HY, we guarantee the following surface roughness values:

Diaphragm foil: Ra  $\leq 0.38$   $\mu$ m

Laser welds: Ra  $\leq 0.76$   $\mu$ m

Turned parts: Ra  $\leq 0.76$   $\mu$ m

Further versions of hygienic design upon request.

### Measuring system

Sensor:

Piezoresistive measuring element

System filling:

Synthetic oil FD1, free of silicone, FDA compliant

## Measuring accuracy

Reference cond. per EN 61298-1:	$T_U = \text{const. (15...25) } ^\circ\text{C}$ $\varphi = \text{konst. (45...75) \% r.F.}$ $p_U = \text{const. (860...1060) mbar}$ $U_B = 24 \text{ V DC } (\pm 3 \text{ V DC})$ $R_B = 50 \ \Omega, \text{ HART: } 250 \ \Omega$ Ground connected MBA = 0 bar
Calibration position:	Process connection bottom: vertical Process connection back: horizontal

Reference accuracy:

Per EN 60770 incl. non-linearity, hysteresis and repeatability refer to the adjusted measuring span:

Nominal range	Turndown $\leq 5:1$	Turndown $> 5:1$
1 - 40 bar	$\leq \pm 0.1 \%$	$\leq \pm 0.02 \% \times \text{TD}$
0.25 bar	$\leq \pm 0.15 \%$	$\leq \pm 0.03 \% \times \text{TD}$

Option:

Nominal range	Turndown $\leq 3,75:1$	Turndown $> 3,75:1$
1 - 40 bar	$\leq \pm 0.075 \%$	$\leq \pm 0.02 \% \times \text{TD}$

Long-term drift:	Refer to nominal range: $\leq 0.1 \%/ \text{year}$
Operational availability:	$< 12 \text{ s}$
Response time $t_{90}$ at current output:	For 20 Hz measuring rate: typ. 120 ms For 100 Hz measuring rate: typ. 50 ms

Temperature influence case:

Refer to nominal range:		
Nominal range	Temp. $-20...80 \text{ } ^\circ\text{C}$	Temp. $-40...-20 \text{ } ^\circ\text{C}$
1 - 40 bar	$\leq \pm 0.1 \%/10\text{K}$ , max. 0.3 %	typisch $\leq \pm 0.2 \%/10\text{K}$
0.25 bar	$\leq \pm 0.15 \%/10\text{K}$ , max. 0.4 %	

Temperature influence process connection:

For a detailed calculation of the temperature influence by the process connection, please contact us.  
For certain variants, a temperature compensated version is available, which improves the temperature error by up to a factor of 10.

Please see: General Technical Information TA\_041, **ATC-technology**.

## Indication

Display:	- High-resolution graphic display with backlight - 4-button operation - Freely configurable display modes - continuously rotatable - Optional: Remote display and control unit (max. 10 m)
Configuration memory:	All parameterisation data can be copied from the device into the configuration memory in the display module. The data is permanently stored there, even in the event of power failure. The parameters can be transferred simply and quickly to other devices.

## Output

Signal:	2-wire technology	4...20 mA
	Lower limit	3.8...4 mA
	Upper limit	20...21 mA
	Lower alarm current	$< 3.6 \text{ mA}$
	Upper alarm current	$> 21 \text{ mA}$
	Current limitation	22 mA
Digital communication:		HART ® protocol, version 7

Device driver:

- EDD für SIMATIC PDM
- DTM for PACTware or compatible systems (FDT compliance)
- EDD for 375 / 475 Field Communicator

Function:	■ linear ■ inverse response ■ by square root ■ table function with up to 64 support points
-----------	---

Turndown:	Max. 100:1
Damping:	0...999.9 s selectable in steps of 0.1 s
Measuring rate:	20 Hz, switchable to 100 Hz
Resolution:	0.5 $\mu\text{A}$
Current sensing func.	3.55...21.5 mA selectable in steps of 0.001 mA
Load R:	$R \leq (U-12\text{V DC})/0.022 \text{ A } [\Omega]$ U = supply voltage for HART ® communication $R \geq 230 \ \Omega$

## Supply voltage

Functional range:	12...30 V DC, protected against polarity reversal
Ripple:	$< 5 \%$

## Temperature ranges

Ambient: -40...80 °C  
(Display visibility is limited at temperatures below -30 °C)

Media: -20...160 °C  
at  $T_a \leq 70$  °C, > 500 mbar abs  
with temperature decoupler up to 200 °C  
 $T_a$  = ambient temperature

### Negative pressure application:

For detailed information on limits of use for negative pressure applications, see General Technical Information TA\_038.

Storage: -40...80 °C

## Tests and certificates

### Ex approvals

ATEX: TÜV 13 ATEX 120264 X  
⊕ II 1/2G Ex ia IIC TX Ga/Gb  
⊕ II 1/2D Ex ia IIIC Txx °C Da/Db  
⊕ II 2G Ex ia IIC TX Gb  
⊕ II 2D Ex ia IIIC Txx °C Db

IECEX: IECEX TUN 13.0018X  
Ex ia IIC TX Ga/Gb  
Ex ia IIIC Txx °C Da/Db  
Ex ia IIC TX Gb  
Ex ia IIIC Txx °C Db

UKEX: CML 21UKEX21179X  
⊕ II 1/2G Ex ia IIC TX Ga/Gb  
⊕ II 1/2D Ex ia IIIC Txx °C Da/Db  
⊕ II 2G Ex ia IIC TX Gb  
⊕ II 2D Ex ia IIIC Txx °C Db

Detailed information can be found in the Ex instructions XA\_010 and XA\_011 (depending on the Ex versions, see order details).

EMC \*: Per DIN EN 61326-1, NAMUR NE21  
\* A deviation of accuracy due to EMC influence up to 0.25 % is impossible for a design with process connection at the back.

SIL 2: Functional safety per EN 61508, classification per SIL2  
For detailed information see SIL instruction SA\_001

NAMUR: Approved according to NE95,  
Test report TP14033 available upon request

## Parameterisation, simulation and adjustment

### Parameterisation

Parameter	Values	Default setting
<b>Device</b>		
device ID	16 digits, freely selectable	LABOM PASCAL Ci4
lower range value	at any value within nominal range	0 bar respectively 0 bar abs.
upper range value	at any value within nominal range	end of nominal range
measuring rate	20 Hz, 100 Hz	20 Hz
damping	0.0...999.9 s	0.0 s
<b>Display and control unit</b>		
pressure unit	mbar, bar, Pa, hPa, kPa, MPa, g/cm <sup>2</sup> , kg/cm <sup>2</sup> , psi, atm, Torr, mmH <sub>2</sub> O, mH <sub>2</sub> O, inH <sub>2</sub> O, ftH <sub>2</sub> O, mmHg, inHg	bar
temperature unit	°C, °F, °R, K	°C
lighting	on, off	on
language	English, German	German
	English, Chinese	as ordered
	English, Spanish, French	as ordered
	English, Polish, German	as ordered
	English, Turkish, German	as ordered
decimal point	auto, x.xxxx, xx.xxx, xxx.xx, xxxx.x, xxxxx	auto
display mode	five values, four values, three values, two values, big display	four values
main value	pressure, current (%), current (mA)	pressure
secondary values	pressure, current (%), current (mA), sensor temperature, device ID, HART-TAG, HART descriptor, <empty>	current (%), current (mA), device ID
<b>Current output</b>		
output function	linear, inverse response, by square root, table function	linear
table function	% of m.r., output current	depends on device
number of table points	2...64	2 (0 % ≙ 4 mA, 100 % ≙ 20 mA)
lower current limit	3.8...4.0 mA	3.8 mA
upper current limit	20...21 mA	20.5 mA
alarm current	low (<3.6 mA), high (> 21.0 mA)	low (<3.6 mA)
position correction (mounting position)	on, off	off
<b>Maintenance counter</b>		
maintenance interval	0...9999 days	0 days
status	on, off	off
<b>HART data</b>		
HART address	0...63	0
number of response preambels	5...20	5
current mode	proportional, constant	proportional

### Diagnostic functions

Self- diagnosis	Description	Value range
RAM-Test	Permanent check of the read/write memory	/
ROM-Test	Permanent check of the checksum via the program memory	/
Bridge circuit test	Permanent check of the bridge circuit	/
CRC parameterisation test	Permanent check of the checksum via the parameter memory	/
Electronics temperature monitoring	Permanent check of the electronics temperature	/
<b>Process diagnostics</b>		
Maintenance timer	Check of the maintenance cycles	/
Operating hours counter	Capture of operating hours	/
Min/Max values	For process pressure and sensor temperature	/
<b>Measuring circuit diagnostics</b>		
loop-test	Setting of a fixed current value at the output	3.55...21.5 mA
pressure simulation	Setting a fixed pressure value, it also considers dampingk and tabular function unlike the current simulation	Nominal range

## Adjustment

Type	Description
zero point correction	adjusts reading to zero at ambient pressure (for differential and gauge pressure devices)
position correction	adjusts reading of mounted device to zero at ambient pressure
lower adjustment	adjusts reading to applied pressure (affects zero point + span)
upper adjustment	adjusts reading to applied pressure (affects span only)
current adjustment	adjusts current output to achieve 4 resp. 20 mA at the end of the measurement chain

## Alternative and additional possibilities of parameterisation for devices with level software LAB4Level

Parameter	Values	Default setting
<b>Display and control unit</b>		
filling height unit	mm, cm, m, ft, in, yd	m
volume unit	l, hl, m <sup>3</sup> , in <sup>3</sup> , ft <sup>3</sup> , gal	l
weight unit (mass)	g, kg, t, lb	kg
density unit	g/cm <sup>3</sup> , kg/cm <sup>3</sup> , t/m <sup>3</sup> , kg/l, lb/in <sup>3</sup> , lb/ft <sup>3</sup>	g/cm <sup>3</sup>
display mode	level 4 values, level 2 values, five values, four values, three values, two values, big display	level 4 values
main value	filling height, volume, weight, pressure, current in %, current in mA	filling height
secondary values	filling height, volumen, weight, pressure, static pressure, current in %, current in mA, sensor temperature, density, device ID, HART-TAG, HART-Descriptor, <leer>	current in %, current in mA, device ID
<b>Level</b>		
density	0.1...20 g/cm <sup>3</sup>	1 g/cm <sup>3</sup>
offset height	max 99.999 m	0 m
tank shape table	on/off	off (= linear)
table function	64 support points (filling heights/volume)	
<b>Current output</b>		
measured value	height, volume, weight, pressure (equal 4...20 mA)	height
number of table points	0 / 2...64	0

## Diagnostic functions

Measuring circuit diagnostics		
simulation function	pressure, filling height, volume, weight (mass), current	/
min/max values	for process pressure, sensor temperature, filling height, volume and weight	/

## Connection diagram

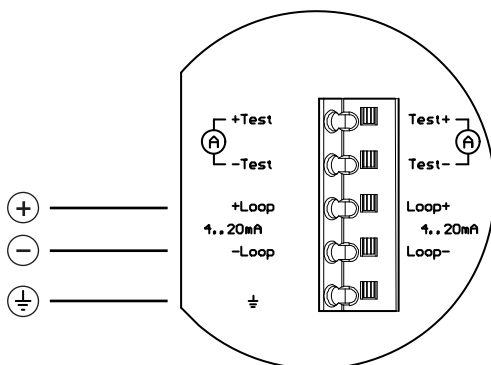

Cable gland

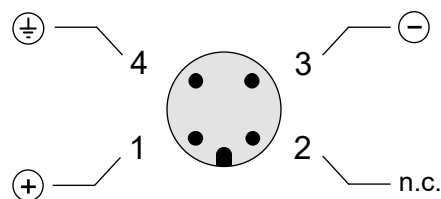

Circular connector M12 x 1

# Dimensions

## Case

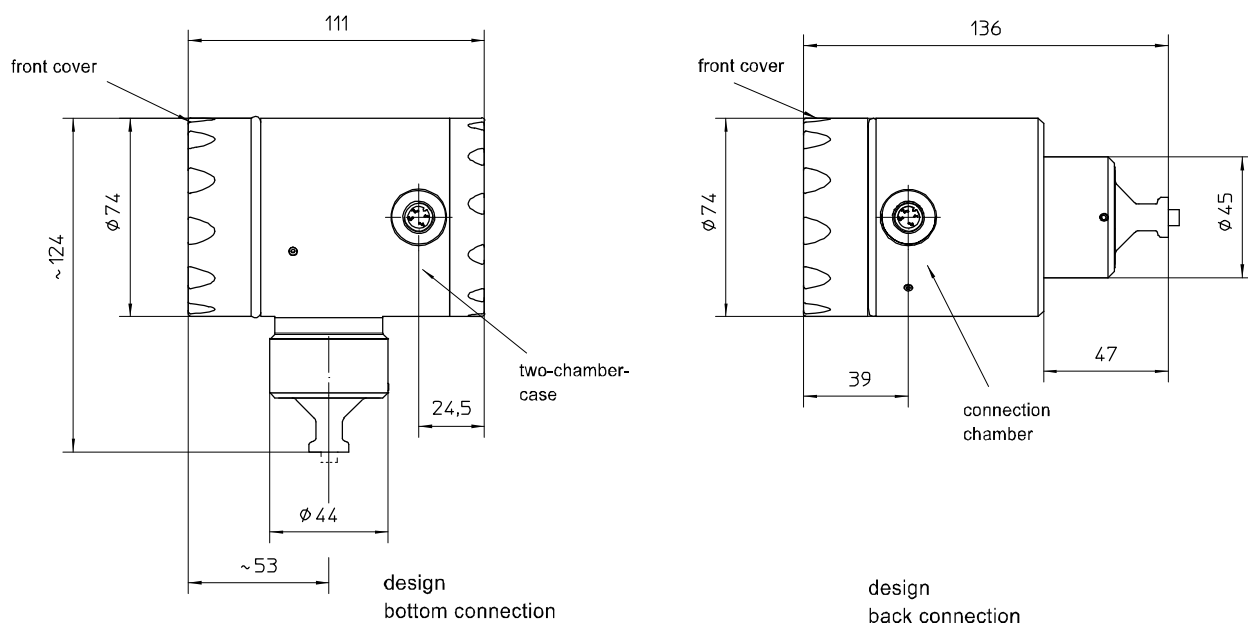

All dimensions are in mm

## Electrical connections

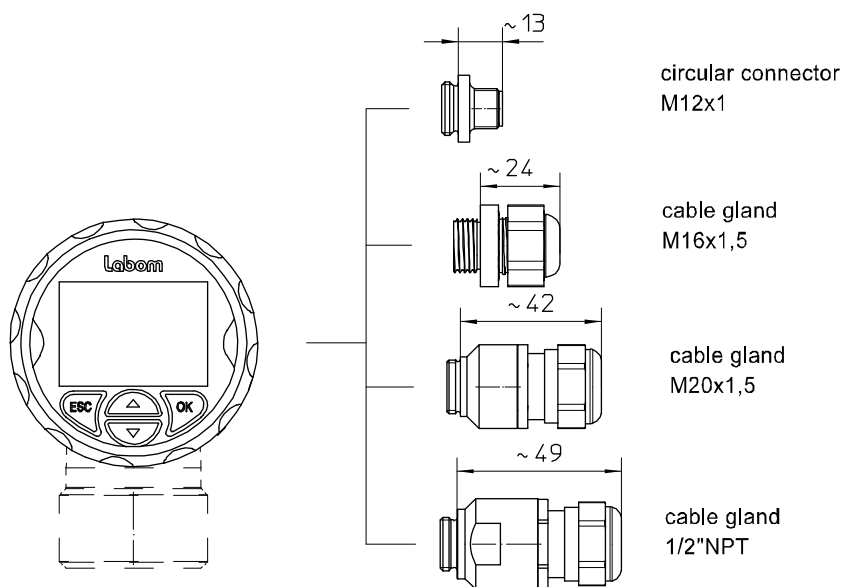

All dimensions are in mm

## Connection

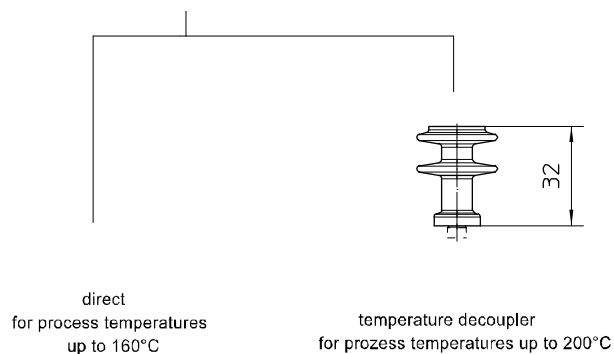

All dimensions are in mm

## Process connection

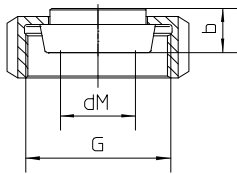

sanitary connection  
with coupling nut  
per DIN 11851

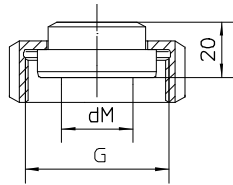

aseptic screw joint  
collar connection  
with union nut per  
DIN 11864-1

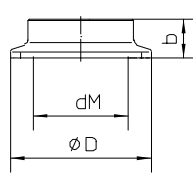

clamp connection  
per DIN 32676/ISO 2852

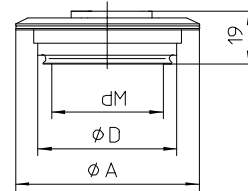

VARIVENT<sup>®</sup> connection for  
VARINLINE<sup>®</sup> case

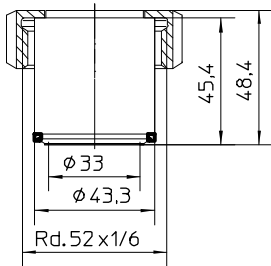

HYGENIC-Tubus \*  
Ø43,3 with screwing  
DN25/PN40

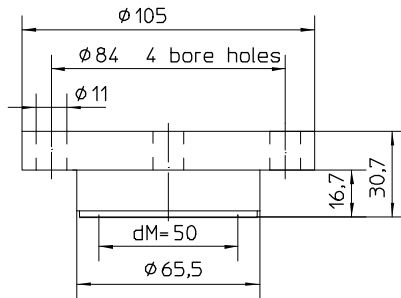

DRD-connection DN50 PN40 \*

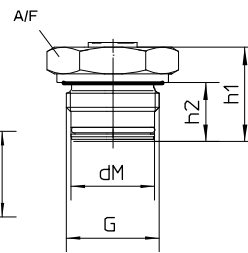

Screw-in thread \*  
with O-ring-gasket  
and additionally gasket  
per DIN EN ISO 1179-2  
model E (DIN 3852)

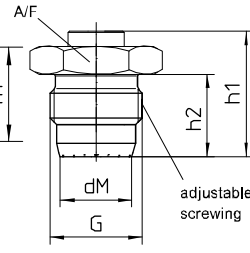

HYGENIC-screw-in thread \*  
no gasket  
tightening torque  
20 Nm, max. nominal pressure 10 bar  
50 Nm, max. nominal pressure 50 bar

\* weld-in adapter  
see data-sheet D6-037

All dimensions are in mm

### Sanitary pipe connection with union nut per DIN 11851

DN	PN	dM	b	G
25	40	27	16	Rd.52x1/6"
32	40	34	16	Rd.58x1/6"
40	40	40	16	Rd.65x1/6"
50	25	51	17	Rd.78x1/6"

### Aseptic screw joint collar connection with union nut per DIN 11864-1

DN	PN	dM	G
25	40	24	Rd.52x1/6"
32	40	30	Rd.58x1/6"
40	40	34	Rd.65x1/6"
50	25	48	Rd.78x1/6"

### Clamp connection per DIN 32676 model A (metric) for pipes per EN 10357 (DIN 11850)

DN	PN	dM	b	D
25	25	22.6	14	50.5
32	25	27	12	50.5
40	25	34	12	50.5
50	16	46	14	64

### Clamp connection per DIN 32676 model B (OD, ISO) for pipes per DIN EN ISO 1127

DN	PN	dM	b	D
26.9	25	22.6	14	50.5
33.7	25	27	12	50.5
42.4	25	34	12	64
48.3	16	40	14	64

### Clamp connection per DIN 32676 model C (Tri-Clamp) for pipes per ASME BPE

DN	PN	dM	b	D
3/4"	25	15.5	15	25
1"	25	22.6	14	50.5
1 1/2"	25	34	12	50.5
2"	16	46	14	64

### Clamp connection per ISO 2852 for pipes per ISO 2037

DN	PN	dM	b	D
25	16	22.6	14	50.5
38	16	34	12	50.5
51	16	46	14	64

### VARIVENT<sup>®</sup> connection for VARINLINE<sup>®</sup> access unit

Connection	PN	dM	A	D
Form F	25	40	66	50
Form N	25	58	84	68

### HYGENIC screw-in thread, gasket without elastomer

G	PN (bar)	dM	h1	h2	SW
G1 A	50	24	45	28.5	36

### Screw-in thread with O ring gasket

G	PN (bar)	dM	h1	h2	SW
G1/2 A	200	15.5	33	20.5	27
G1 A	50	24	33	20.5	41



## Remote display and control unit (Type series MC1140)

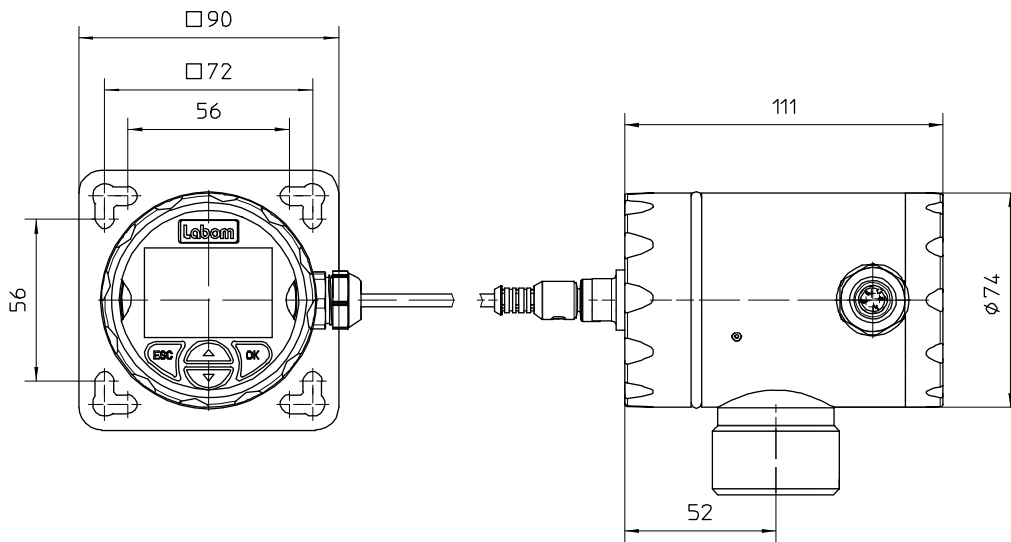

All dimensions are in mm

## Order details

Pressure transmitter PASCAL CI411. for diaphragm seal operation, hygienic								
CI4110	process connection bottom							
CI4113	process connection back							
	nominal range	turndown	overload limit [bar]	higher overload limit [bar]	Ex marking (see below)	sensor type		
A1053	0...1 bar	TD up to 100:1	3	-	S66 / S76 / S86	piezoresistive		
A1056	0...4 bar		10	-	S66 / S76 / S86			
A1059	0...16 bar		60	-	S66 / S76 / S86			
A1061	0...40 bar		100	-	S66 / S76 / S86			
A1063	0...100 bar		200	-	S62 / S77 / S87			
A1178	-0,25...0,25 bar		1	-	S66 / S76 / S86			
A1153	-1...1 bar		3	-	S62 / S77 / S87			
A1156	-1...4 bar		10	-	S62 / S77 / S87			
A1159	-1...16 bar		60	-	S62 / S77 / S87			
A1161	-1...40 bar		100	-	S62 / S77 / S87			
A1178.1	-0.25...0.25 bar		-	6	S62 / S77 / S87			
A1153.1	-1...1 bar		-	10	S62 / S77 / S87			
A1156.1	-1...4 bar		-	25	S62 / S77 / S87			
A1159.1	-1...16 bar		-	120	S62 / S77 / S87			
A1161.1	-1...40 bar		-	120	S62 / S77 / S87			
B1053	0...1 bar abs		3	-	S66 / S76 / S86			
B1056	0...4 bar abs		10	-	S66 / S76 / S86			
B1059	0...16 bar abs		60	-	S66 / S76 / S86			
B1061	0...40 bar abs		120	-	S62 / S77 / S87			
F1	parameterisation		factory settings (standard)					
F2		as per customer's specification (pls. specify)						
H21	output signal	4...20 mA, with HART protocol						
Y1.	material case	stainless steel mat.-no. 1.4301 (304)						
Y2.		stainless steel mat.-no. 1.4404 (316)						
1	material front cover	polypropylene (black), window Macrolon						
2		stainless steel like case, window non splintering glass						
3		stainless steel like case, closed, without window						
				default language	available language			
M21.1	display	High-resolution graphic display with backlight, intuitive 4-button operation, quick access to device data		German (standard)	English, German			
M22.1				English	English, Chinese			
M22.2				Chinese	English, Spanish, French			
M23.1				English	English, Polish, German			
M23.2				Spanish	English, Turkish, German			
M23.3				French				
M25.1				English				
M25.2				Polish				
M25.3				German				
M26.1				English				
M26.2				Turkish				
M26.3				German				
M1				without display				
T20.			electrical connection	cable gland		M16 x 1.5 polyamide, for cable Ø 4.5-10 mm		
T22.		M16 x 1.5 stainless steel mat.-no. 1.4404 (316L), for cable Ø 5-9 mm						
T15.		M20 x 1.5 polyamide, for cable Ø 7-13 mm						
T17.		M20 x 1.5 stainless steel mat.-no. 1.4404 (316L), for cable Ø 8-13 mm						
T27.		1/2" NPT polyamide, for cable Ø 6-12 mm						
0	cable clamps			spring clamp terminals up to 1.5 mm <sup>2</sup>				
5				pole terminals 2.5 mm <sup>2</sup>				
6				screwed terminals 2.5 mm <sup>2</sup>				
T30		circular connector M12 x 1 (4 pin)						

Continuation order code			
K1085	design	standard	
K2085		with temperature decoupler	
K102	process connection material: ASTM 316L	sanitary pipe connection with union nut per DIN 11851 <sup>1,2</sup>	DN 25
K103			DN 32
K104			DN 40
K105			DN 50
K162			DN 25
K163		DN 32	
K165		DN 40	
K166		DN 50	
K124		clamp connection per ISO 2852 for pipes per ISO 2037 <sup>1,2</sup>	DN 25 (1")
K126			DN 38 (1 1/2")
K127			DN 51 (2")
K144		clamp connection per DIN 32676, model A (metric) for pipes per EN 10357 (DIN 11850) <sup>1,2</sup>	DN 25
K146			DN 32
K147			DN 40
K148			DN 50
K213			DN 26,9
K214		clamp connection per DIN 32676, model B (OD, ISO) for pipes per DIN EN ISO 1127 <sup>1,2</sup>	DN 33,7
K215			DN 42,4
K216			DN 48,3
K134		clamp connection per DIN 32676, model C (Tri-Clamp) for pipes per ASME BPE <sup>1,2</sup>	DN 3/4" <sup>3</sup>
K136			DN 1"
K137			DN 1 1/2"
K138			DN 2"
K152		VARIVENT® connection <sup>1,2</sup>	Form F (D=50) for VARINLINE® access unit
K153			Form N (D=68) for VARINLINE® access unit
K172		HYGIENIC Tubus	Ø 43,3 mm with screwing DN 25/PN 40
K185		DRD connection	nominal width DN 50 / nominal pressure PN 40
K195		screw-in thread	G 1 A with O-ring seal
K80	G 1 A with hygienic process connection (elastomer-free)		
HY	surface roughness (wetted parts)	Hygienic version as per EHEDG Doc. 8 and ASME BPE SF3	

Additional features (to be indicated if required)			
Q11	Accuracy	≤ 0.075 <sup>4</sup>	
S66		ATEX	Ex II 1/2G, II 2G Ex ia IIC TX Ga/Gb, Gb
			Ex II 1/2D, II 2D Ex ia IIIC Txx°C Da/Db, Db
S76	Ex marking <sup>5</sup> (details see Ex Instruction XA_010)	IECEX	Ex ia IIC TX Ga/Gb, Gb
			Ex ia IIIC Txx°C Da/Db, Db
S86		UKEX	Ex II 1/2G, II 2G Ex ia IIC TX Ga/Gb, Gb
			Ex II 1/2D, II 2D Ex ia IIIC Txx°C Da/Db, Db
S62		ATEX	Ex II 1/2G, II 2G Ex ia IIC TX Ga/Gb, Gb
			Ex II 1/2D, II 2D Ex ia IIIC Txx°C Da/Db, Db
S77	Ex marking <sup>5</sup> (details see Ex Instruction XA_011)	IECEX	Ex ia IIC TX Ga/Gb, Gb
			Ex ia IIIC Txx°C Da/Db, Db
S87		UKEX	Ex II 1/2G, II 2G Ex ia IIC TX Ga/Gb, Gb
			Ex II 1/2D, II 2D Ex ia IIIC Txx°C Da/Db, Db
X1	vacuum application	negative pressure service	temperature limits see TA_038 Pressure Transmission Fluids
X2		vacuum service	
X3	Active Temperature Compensation (ATC) <sup>6</sup>		
X4	operating software LAB4Level for level applications		
T4	degree of protection	IP 69K <sup>5</sup>	
W4035	elektropolishing	wetted parts	
W1020	material certificate	per DIN EN 10204-3.1, wetted parts	
W1201	calibration certificate	per DIN EN 10204-3.1, 5 measuring points	
W2602	functional safety per EN 61508, classification per SIL2		
W2660	as per UKCA regulations		

Accessories		
<b>MC1140</b>	PASCAL Ci4 remote display and control unit including wall bracket	
	material stainless steel, incl. front ring with seal and blind cap with circular connector M12x1	
<b>A1.</b>	connection cable	length: 10 m, material: PUR, with circular connector M12 x1 (further lengths upon request)
<b>1</b>	internal cable clamps	spring clamp terminals up to 1.5 mm <sup>2</sup>
<b>2</b>		pole terminals 2.5 mm <sup>2</sup>
<b>3</b>		screwed terminals 2.5 mm <sup>2</sup>
<b>T1</b>	degree of protection	IP 65 / IP 67 (standard)
<b>MZ8120-A11</b>	mounting set for wall bracket	2 mounting brackets for pipe and frame mounting Ø 30-50 mm, incl. nuts and washers
<b>MZ8120-A12</b>		2 mounting brackets for pipe and frame mounting Ø 40-64 mm, incl. nuts and washers

**Order code (example):** CI4110 – A1056 – F1 – H21 – Y12 – T200 – K1085 – K102 - ...

- <sup>1</sup> EHEDG certified only in connection with hygienic design (order code option HY)
- <sup>2</sup> EHEDG certificate valid only if gaskets are used that are listed in the "EHEDG position paper"
- <sup>3</sup> for a function calculation and optimim system design it is necessary to specify the operation temperature
- <sup>4</sup> only for nominal ranges: 1...40 bar at a Turndown of ≤ 3.75:1
- <sup>5</sup> Requires front cover of stainless steel
- <sup>6</sup> only for devices directly welded