



Pressure transmitter

Huba Control

In Proud Partnership with Huba Control

PAQUIN SENSORS

For technical support, sales, & distribution
within the USA & Canada

www.paquin.com | (800) 831-8217 | paquinsensors@paquin.com

Relative pressure transmitter Type 520

The compact type 520 pressure transmitter is based upon the Huba Control developed thick film technology where the pressure measuring cell is fully welded. This transmitter meets the high burst protection demands and is suitable for the use in all types of refrigerants including ammonia.



Pressure range

-1 ... 9 bar /

0 ... 2.5 – 1000 bar

- + Compact, rugged construction
- + Welded without sealing parts, no elastomer seals
- + Large selection of connections available.
- + Saving time by quick cable mounting by the customer with swift connector

Technical overview

Pressure range

Relative -1 ... 9 bar / 0 ... 2.5 - 1000 bar

Operating conditions

Medium	Liquids, gases and refrigerants (incl. ammonia)
Temperature	Medium -40 ... +135 °C (E) -30 ... +120 °C Ambient -30 ... +85 °C (E) -25 ... +85 °C Storage -50 ... +100 °C
Tolerable overload	≤ 6 bar 5 x fs > 6 bar 3 x fs (max. 1500 bar)
Rupture pressure	≤ 6 bar 10 x fs > 6 bar 6 x fs (max. 2500 bar)

Materials

Cover	Stainless steel 1.4404 / AISI 316L (inside thread Schrader 1.4305 / AISI 303 only)
Plug accommodation	Polyarylamide 50% GF UL 94 V-0
Materials in contact with medium	Pressure connection Sensor
	Stainless steel 1.4404 / AISI 316L (inside thread Schrader 1.4305 / AISI 303 only) Stainless steel

Electrical overview

	Output	Power supply	Load	Current consumption
2 wire	4 ... 20 mA	7 ... 33 VDC	< $\frac{\text{supply voltage} - 7 \text{ V}}{0.02 \text{ A}}$ [Ohm]	< 23 mA
	4 ... 20 mA	10 ... 30 VDC	< $\frac{\text{supply voltage} - 10 \text{ V}}{0.02 \text{ A}}$ [Ohm]	< 23 mA
	0 ... 5 V	7 ... 33 VDC	> 10 kOhm / < 100 nF	< 7 mA
3 wire	1 ... 6 V	8 ... 33 VDC	> 10 kOhm / < 100 nF	< 7 mA
	0 ... 10 V	12 ... 33 VDC	> 10 kOhm / < 100 nF	< 7 mA
	0 ... 10 V	12 ... 33 VDC / 24 VAC ± 15%	> 10 kOhm / < 100 nF	< 7 mA
	ration. 10 ... 90%	5 VDC ± 10%	> 10 kOhm / < 100 nF	< 7 mA
	(E) ration. 10 ... 90%	5 VDC ± 10%	> 10 kOhm / < 100 nF	< 7 mA
Polarity reversal protection	Short circuit proof and protected against polarity reversal. Each connection is protected against crossover up to max. supply voltage.			
Insulation voltage	standard			500 VDC

Dynamic response

Response time	< 2 ms, 1 ms typ.
Load cycle	< 100 Hz

Electrical connection

Electrical connection	Protection standard	Protection class
Swift connector with or without cable 1.5 / 2.0 / 3.0 / 5.0 m (PVC spec.)	IP 67	III
Connector DIN EN 175301-803-A or C (industrial standard 9.4 mm)	IP 65	III
Metri Pack Serie 150	IP 67	III
Connector M12x1	IP 67	III
Braids	IP 65	III
Connector RAST 2.5 (3 wire, only)	IP 00	III

Pressure connection

Inside thread	$\frac{7}{16}$ - 20 UNF	without or with Schrader
	$\frac{1}{2}$ - 14 NPT	(≤ 60 bar)
	G $\frac{1}{4}$	with O-Ring seal FPM (-30 ... +135 °C)
Outside thread	$\frac{7}{16}$ - 20 UNF	sealing cone 45°
	$\frac{1}{4}$ - 18 NPT	
	$\frac{7}{16}$ - 20 UNF	sealed at back SAE 4 with O-Ring seal FPM (-20 ... +135 °C)
	G $\frac{1}{4}$	sealed at back ISO 1179-2 (DIN 3852-E) with profile seal ring in FPM (-30 ... +135 °C)
	G $\frac{1}{4}$	sealed at back and manometer (combi) with profile seal ring in FPM (-30 ... +135 °C) (≤ 60 bar)
	R $\frac{1}{4}$	EN 10226
	G $\frac{1}{2}$	sealed at back and manometer (combi) with profile seal ring in FPM (-30 ... +135 °C)
	$\frac{1}{8}$ - 27 NPT	(≤ 60 bar)
	G $\frac{1}{8}$	sealed at front (≤ 60 bar)
	G $\frac{1}{8}$	sealed at back ISO 1179-2 (DIN 3852-E) with profile seal ring in FPM (-30 ... +135 °C) (> 60 bar - without ATEX certificate)
	M10x1	sealed at back ISO 9974-2 (DIN 3852-E) with Profile seal ring in FPM (-30 ... +135 °C) (≤ 60 bar)
M20x1.5	sealed at front and manometer (combi)	
G $\frac{1}{2}$, G $\frac{1}{4}$	sealed at front	

Installation arrangement

Unrestricted

Tests / Admissions

Electromagnetic compatibility	CE conformity acc. EN 61326-2-3
Enhanced EMC protection	EN 50121-3-2
Shock acc. IEC 68-2-27	100 g, 11 ms half sine wave, all 6 directions, free fall from 1 m on concrete (6x)
Constant shock acc. IEC 68-2-29	40 g for 6 ms, 1000x all 3 directions
Vibration acc. IEC 68-2-6	20 g, 15 ... 2000 Hz, 15 ... 25 Hz with amplitude ± 15 mm, 1 Octave/min. all 3 directions, 50 constant load
UL	ANSI/UL 61010-1 acc. E325110
Drinking water approval	NSF/ANSI 61/372 acc. MH60087
EAC	WRAS

Protection against explosion (E)

	ration. 10 ... 90%	4 ... 20 mA
Intrinsic safety «i»	Ex II 1/2 G Ex ia IIC T4 Ga/Gb	Ex II 1/2 G Ex ia IIC T4 Ga/Gb
EC type examination certificate	Ex II 1/2 D Ex ia IIIC T125°C Da/Db	Ex II 1/2 D Ex ia IIIC T125°C Da/Db
Connection to certified intrinsically safe resistive circuits with maximum values	SEV 15 ATEX 0173	SEV 10 ATEX 0145
Effective internal inductance and capacitance for versions with plugs complying with EN 175301-803-A or M12x1	Ui ≤ 15 VDC; li ≤ 200 mA; Pi ≤ 750 mW	Ui ≤ 30 VDC; li ≤ 100 mA; Pi ≤ 750 mW
IECEx	Li = 0 nH; Ci ≤ 150 nF	Li = 0 nH; Ci = 0 nF
		SEV 16.0007

Weight

~ 90 g

Packaging (Please state on order)

Single packaging in cardboard	accessories integrated
Multiple packaging in cardboard (25 pcs)	

Accuracy

Parameter	Unit	
Characteristic line a ¹⁾	% fs	± 0.3
Resolution	% fs	0.1
Thermal characteristic ²⁾	max. % fs/10K	± 0.2
Long term stability acc. EN 60770-1	max. % fs	± 0.25

Test conditions: 25 °C, 45% RH, power supply 24 VDC

Order code selection table in bar		1	2	3	4	5	6	7	8	9	10	11
		520.	X	X	X	X	X	X	X	X	X	X
Pressure range ³⁾	-1 ... 9 bar	9	0	6								
	0 ... 2.5 bar	9	1	4								
	0 ... 4 bar	9	1	5								
	0 ... 6 bar	9	1	7								
	0 ... 10 bar	9	3	0								
	0 ... 16 bar	9	3	1								
	0 ... 25 bar	9	3	2								
	0 ... 40 bar	9	3	3								
	0 ... 60 bar	9	4	0								
	0 ... 100 bar	9	4	1								
	0 ... 160 bar	9	4	2								
	0 ... 250 bar	9	4	3								
	0 ... 400 bar	9	5	4								
	0 ... 600 bar	9	5	5								
	0 ... 1000 bar	9	5	7								
Application	standard					S	0					
	for oxygen applications					S	1			0		
	with drinking water approval NSF/ANSI 61/372, WRAS					S	4			0	1	
Output / power supply	0 ... 5V							1				
	1 ... 6V							6				
	0 ... 10V	7 ... 33 VDC							2			
		12 ... 33 VDC Enhanced EMC protection							C	1,2,3		
	ratiom. 10 ... 90%	12 ... 33 VDC / 24 VAC ±15% (not possible with M12x1, metri Pack, RAST, braids)							8			
		5VDC ±10%							7			
	4 ... 20 mA	5VDC ±10% Ex protection					0,4		9	1,3		1
		7 ... 33 VDC							3			
Electrical connection	7 ... 33 VDC Enhanced EMC protection (not possible with Braids)							A				
	10 ... 30 VDC Ex protection					0,4		4	1,3		1	
	Connector ⁴⁾	DIN EN 175301-803-A								1		
		DIN EN 175301-803-C (industrial standard 9.4 mm)								2		
		M12x1 2w: IN=1 / OUT=3 3w: IN=1 / OUT=4 / GND=3								3		
		M12x1 2w: IN=1 / OUT=4 3w: IN=1 / OUT=3 / GND=4								M		
		M12x1 2w: IN=1 / OUT=2 3w: IN=1 / OUT=2 / GND=3								P		
		RAST 2.5					0,4		7	4		
	Braids	Metri Pack Serie 150					0,4		5			
		80 ±10 mm					0,4		6			
		290 ±10 mm					0,4		7			
		480 ±10 mm					0,4		8			
	Swift connector	730 ±10 mm					0,4		9			
		without cable								0		
		with cable 1.5 m								L		
with cable 2.0 m									N			
with cable 3.0 m									Q			
Pressure connection ²⁾	with cable 5.0 m								R			
	Inside thread	7/16"-20 UNF sealing cone with schrader						0		0	0	N
		7/16"-20 UNF sealing cone								K		1
		1/2"-14 NPT ⁵⁾								D		1
		G 1/4 with O-Ring seal FPM								1		1
		7/16"-20 UNF sealing cone								2		1
	Outside thread	1/4"-18 NPT								3		1
		G 1/4 sealed at back ISO 1179-2 (DIN 3852-E) with profile seal ring in FPM								4		1
		G 1/4 sealed at back and manometer with profile seal ring in FPM								5	0	1
		R 1/4 acc. to EN 10226								7		1
		G 1/2 sealed at back and manometer with profile seal ring in FPM					0,1			8		1
		7/16"-20 UNF sealed at back SAE 4 with O-Ring seal FPM					0,1			G		1
		1/8"-27 NPT ⁵⁾								A		1
		G 1/8 sealed at front ⁵⁾								M		1
		G 1/8 sealed at back ISO 1179-2 (DIN 3852-E) with Profile seal ring in FPM ⁶⁾					0,1			H		1
M10x1 sealed at back ISO 9974-2 (DIN 3852-E) with profile seal ring in FPM ⁵⁾						0,1			F		1	
Pressure orifice	M20x1.5 sealed at front and manometer (combi)								E		1	
	G 1/4 sealed at front								J		1	
	G 1/2 sealed at front								9		1	
Material	without (inclusive pressure tip orifice from 100 bar on)									0		
	with									2		
Material pressure connection	Stainless steel 1.4305 / AISI 303										N	
	Stainless steel 1.4404 / AISI 316L										1	
Pressure range variation (optional)	Indicate W and state range on order (e.g.: W0... + 3bar/OUT0...5V)										W	

¹⁾ typ.; max. 0.5% fs (incl. zero point, full scale, linearity, hysteresis and repeatability)

²⁾ -15 ... 85 °C

³⁾ Other pressure ranges or pressure connections on request

⁴⁾ Delivery without female connector

⁵⁾ Pressure range ≤ 60 bar

⁶⁾ Pressure range ≤ 250 bar (max. rupture pressure 1000 bar)

		1	2	3	4	5	6	7	8	9	10	11	
Order code selection table in psi		520. X X X X X X X X X X X X											
Pressure range ¹⁾	-15 ... 130 psi	9	A	6									
	0 ... 30 psi	9	B	4									
	0 ... 60 psi	9	B	5									
	0 ... 100 psi	9	B	7									
	0 ... 200 psi	9	C	1									
	0 ... 300 psi	9	C	2									
	0 ... 500 psi	9	C	3									
	0 ... 750 psi	9	D	0									
	0 ... 1000 psi	9	D	1									
	0 ... 2000 psi	9	D	2									
	0 ... 3000 psi	9	D	3									
	0 ... 5000 psi	9	E	4									
	0 ... 7500 psi	9	E	5									
0 ... 14500 psi	9	E	7										
Application	standard				S	0							
	for oxygen applications				S	1				0			
	with drinking water approval NSF/ANSI 61/372, WRAS				S	4				0	1		
Output / power supply	0 ... 5 V								1				
	1 ... 6 V								6				
									2				
	0 ... 10 V								C	1,2,3			
										8			
										7			
	ration. 10 ... 90%								0,4	9	1,3	1	
										3			
	4 ... 20 mA									A			
									0,4	4	1,3	1	
Electrical connection	Connector ²⁾	DIN EN 175301-803-A									1		
		DIN EN 175301-803-C (industrial standard 9.4 mm)										2	
		M12x1 2w: IN=1 / OUT=3 3w: IN=1 / OUT=4 / GND=3											3
		M12x1 2w: IN=1 / OUT=4 3w: IN=1 / OUT=3 / GND=4											M
		M12x1 2w: IN=1 / OUT=2 3w: IN=1 / OUT=2 / GND=3											P
		RAST 2.5							0,4	7			4
	Braids	Metri Pack Serie 150											5
		80 ±10 mm								0,4			6
		290 ±10 mm								0,4			7
		480 ±10 mm								0,4			8
	Swift connector	730 ±10 mm								0,4			9
		without cable											0
		with cable 1.5 m											L
with cable 2.0 m												N	
with cable 3.0 m												Q	
Pressure connection ¹⁾	Inside thread	with cable 5.0 m										R	
		$\frac{7}{16}$ -20 UNF sealing cone with schrader					0				0	0	N
		$\frac{7}{16}$ -20 UNF sealing cone											K
	Outside thread	$\frac{1}{2}$ -14 NPT ³⁾											D
		G $\frac{1}{4}$ with O-Ring seal FPM											1
		$\frac{7}{16}$ -20 UNF sealing cone											2
		$\frac{1}{4}$ -18 NPT											3
		G $\frac{1}{4}$ sealed at back ISO 1179-2 (DIN 3852-E) with profile seal ring in FPM											4
		G $\frac{1}{4}$ sealed at back and manometer with profile seal ring in FPM											5
		R $\frac{1}{4}$ acc. to EN 10226											7
		G $\frac{1}{2}$ sealed at back and manometer with profile seal ring in FPM											8
		$\frac{7}{16}$ -20 UNF sealed at back SAE 4 with O-Ring seal FPM						0,1					G
		$\frac{1}{8}$ -27 NPT ³⁾											A
		G $\frac{1}{8}$ sealed at front ³⁾											M
		G $\frac{1}{8}$ sealed at back ISO 1179-2 (DIN 3852-E) with Profile seal ring in FPM ⁴⁾											H
		M10x1 sealed at back ISO 9974-2 (DIN 3852-E) with profile seal ring in FPM ³⁾											F
		M20x1.5 sealed at front and manometer (combi)											E
G $\frac{1}{4}$ sealed at front											J		
G $\frac{1}{2}$ sealed at front											9		
Pressure orifice	without (inclusive pressure tip orifice from 2000 psi on)											0	
	with											2	
Material pressure connection	Stainless steel 1.4305 / AISI 303											N	
	Stainless steel 1.4404 / AISI 316L											1	
Pressure range variation (optional)	Indicate W and state range on order (e.g.: W0... +400psi/OUT0...5V)											W	

¹⁾ Other pressure ranges or pressure connections on request
⁴⁾ Pressure range ≤ 3000 psi (max. rupture pressure 14500 bar)

²⁾ Delivery without female connector

³⁾ Pressure range ≤ 870 psi

		1	2	3	4	5	6	7	8	9	10	11	
Order code selection table in MPa		520. X X X X X X X X X X X X											
Pressure range ¹⁾	-0.1 ... 0.9 MPa	9	F	6									
	0 ... 0.25 MPa	9	G	4									
	0 ... 0.4 MPa	9	G	5									
	0 ... 0.6 MPa	9	G	7									
	0 ... 1 MPa	9	H	0									
	0 ... 1.6 MPa	9	H	1									
	0 ... 2.5 MPa	9	H	2									
	0 ... 4 MPa	9	H	3									
	0 ... 6 MPa	9	K	0									
	0 ... 10 MPa	9	K	1									
	0 ... 16 MPa	9	K	2									
	0 ... 25 MPa	9	K	3									
	0 ... 40 MPa	9	L	4									
0 ... 60 MPa	9	L	5										
0 ... 100 MPa	9	L	7										
Application	standard				S	0							
	for oxygen applications				S	1				0			
	with drinking water approval NSF/ANSI 61/372, WRAS				S	4				0	1		
Output / power supply	0 ... 5 V	7 ... 33 VDC					1						
	1 ... 6 V	8 ... 33 VDC					6						
	0 ... 10 V	12 ... 33 VDC						2					
		12 ... 33 VDC Enhanced EMC protection						C	1,2,3				
		12 ... 33 VDC / 24 VAC ±15% (not possible with M12x1, metri Pack, RAST, braids)						8					
	ratiom. 10 ... 90%	5VDC ±10%						7					
		5VDC ±10% Ex protection					0,4	9	1,3				
4 ... 20 mA	7 ... 33 VDC						3						
	7 ... 33 VDC Enhanced EMC protection (not possible with Braids)						A						
	10 ... 30 VDC Ex protection					0,4	4	1,3					
Electrical connection	Connector ²⁾	DIN EN 175301-803-A								1			
		DIN EN 175301-803-C (industrial standard 9.4 mm)								2			
		M12x1 2w: IN=1 / OUT=3 3w: IN=1 / OUT=4 / GND=3									3		
		M12x1 2w: IN=1 / OUT=4 3w: IN=1 / OUT=3 / GND=4									M		
		M12x1 2w: IN=1 / OUT=2 3w: IN=1 / OUT=2 / GND=3									P		
		RAST 2.5					0,4	7	4				
	Braids	Metri Pack Serie 150					0,4		5				
		.80 ±10 mm					0,4		6				
		290 ±10 mm					0,4		7				
		480 ±10 mm					0,4		8				
		730 ±10 mm					0,4		9				
	Swift connector	without cable									0		
		with cable 1.5 m									L		
with cable 2.0 m										N			
with cable 3.0 m										Q			
Pressure connection ¹⁾	Inside thread	7/16"-20 UNF sealing cone with schrader				0				0	0	N	
		7/16"-20 UNF sealing cone								K		1	
		1/2 -14 NPT ³⁾								D		1	
		G 1/4 with O-Ring seal FPM								1		1	
	Outside thread	7/16"-20 UNF sealing cone									2		1
		1/4 -18 NPT									3		1
		G 1/4 sealed at back ISO 1179-2 (DIN 3852-E) with profile seal ring in FPM									4		1
		G 1/4 sealed at back and manometer with profile seal ring in FPM									5	0	1
		R 1/4 acc. to EN 10226									7		1
		G 1/2 sealed at back and manometer with profile seal ring in FPM					0,1				8		1
		7/16"-20 UNF sealed at back SAE 4 with O-Ring seal FPM					0,1				G		1
		1/8 -27 NPT ³⁾									A		1
		G 1/8 sealed at front ³⁾									M		1
		G 1/8 sealed at back ISO 1179-2 (DIN 3852-E) with Profile seal ring in FPM ⁴⁾					0,1				H		1
		M10x1 sealed at back ISO 9974-2 (DIN 3852-E) with profile seal ring in FPM ³⁾					0,1				F		1
		M20x1.5 sealed at front and manometer (combi)									E		1
		G 1/4 sealed at front									J		1
G 1/2 sealed at front									9		1		
Pressure orifice	without (inclusive pressure tip orifice from 10 MPa on)										0		
	with										2		
Material pressure connection	Stainless steel 1.4305 / AISI 303											N	
Pressure range variation (optional)	Stainless steel 1.4404 / AISI 316L											1	
Pressure range variation (optional)	Indicate W and state range on order (e.g.: W0... + 0.3MPa/OUT0...5V)											W	

¹⁾ Other pressure ranges or pressure connections on request

²⁾ Delivery without female connector

³⁾ Pressure range ≤ 6 MPa

⁴⁾ Pressure range ≤ 25 MPa (max. rupture pressure 100 MPa)

Swift connector	117312
Female connector DIN EN 175301-803-A with seal	103510
Female connector DIN EN 175301-803-C with seal	104244
Corner-wire box for connector M12x1	106975
Corner-wire box for connector M12x1 with cable 2.0 m	114604
Straight-wire box for connector M12x1	114570
Straight-wire box for connector M12x1 with cable 2.0 m	114605
Mounting bracket with screw	118716
Heat sink with outside thread G 1/2 sealed at front - inside thread G 1/2	105631
Heat sink with outside thread G 1/2 sealed at front - inside thread G 1/4	105073
Heat sink with outside thread G 1/4 sealed at front - inside thread G 1/4	105074
Calibration certificate (≤ 600 bar)	104551

Mounting bracket

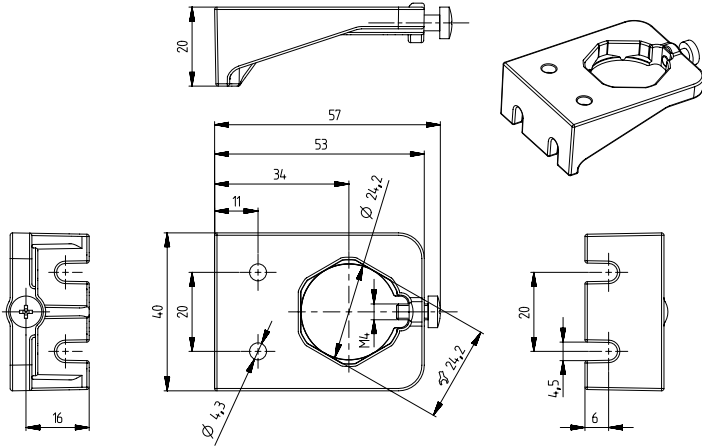

Heat sink

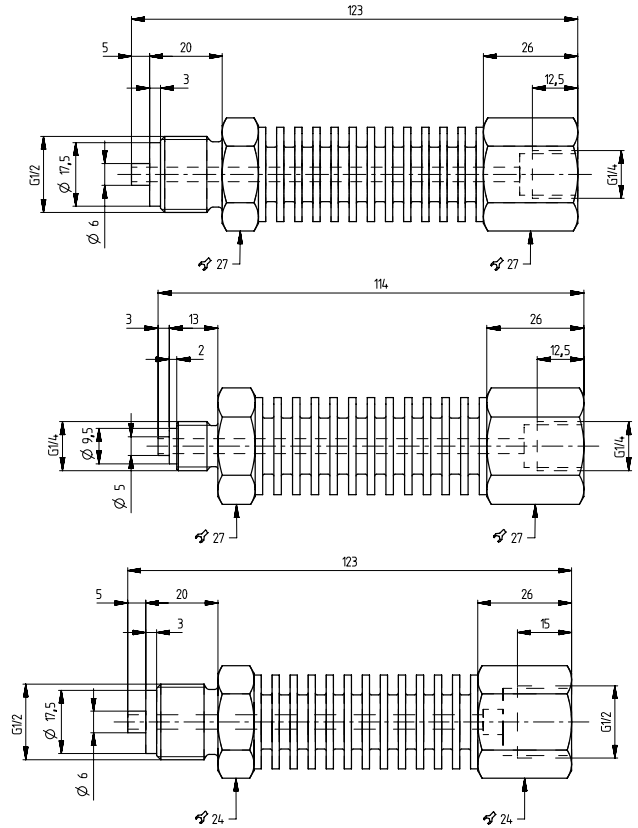

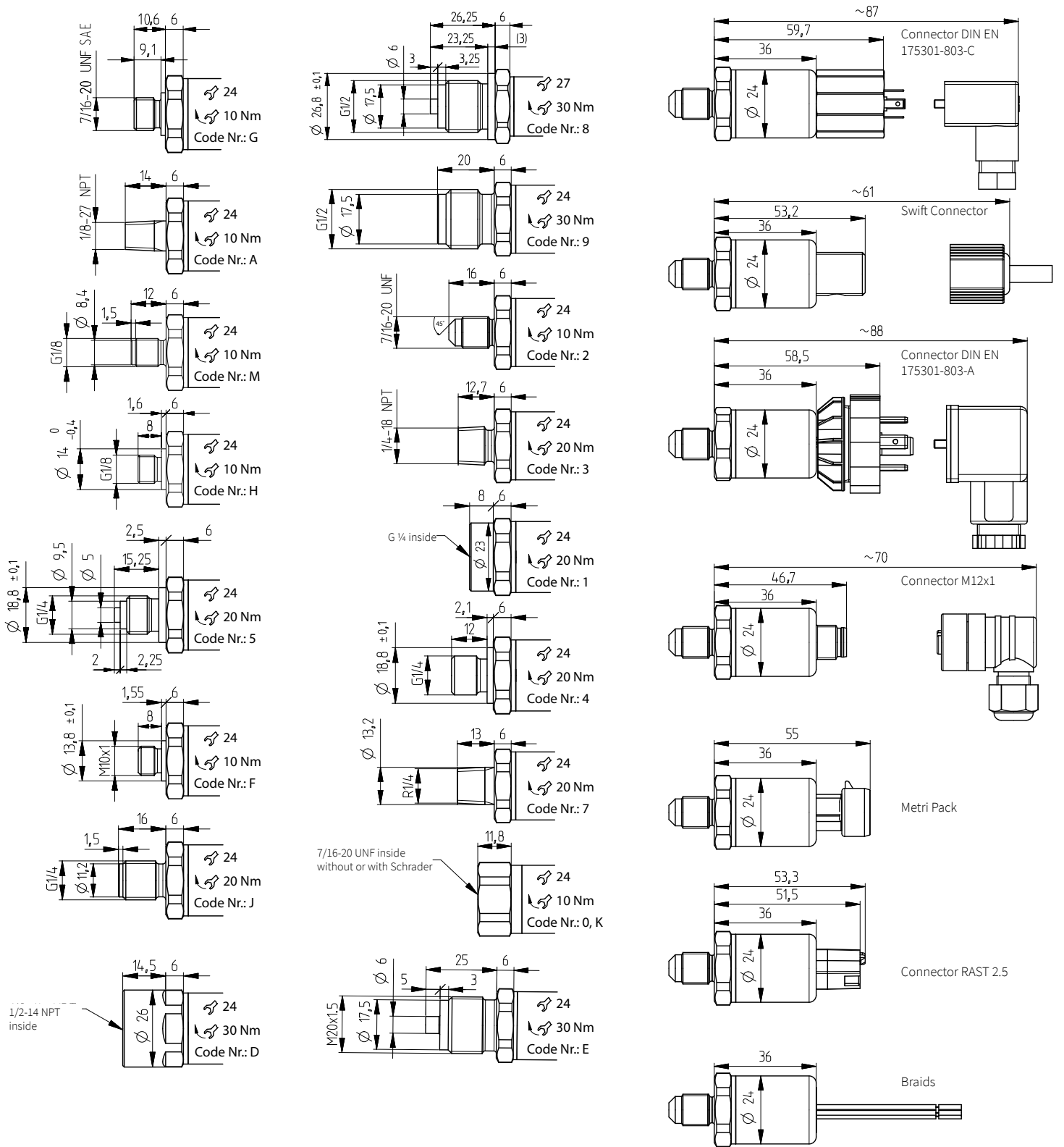

2 wire

Connector DIN
EN 175301-803-A or C

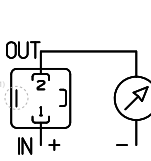

1 (IN) 2 (OUT)

Swift connector

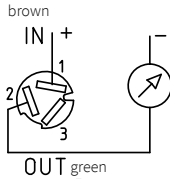

1 (IN) 2 (OUT)

Connector M12x1

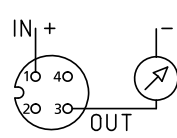

1 (IN) 3 (OUT)

Connector M12x1

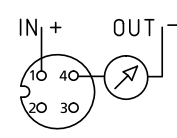

1 (IN) 4 (OUT)

Connector M12x1

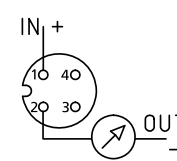

1 (IN) 2 (OUT)

Metri Pack Serie 150

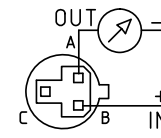

B (IN) A (OUT)

Braids

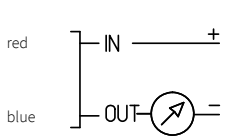

3 wire

Connector DIN
EN 175301-803-A or C

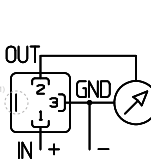

1 (IN) 2 (OUT) 3 (GND)

Swift connector

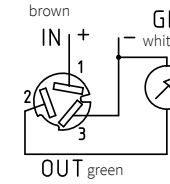

1 (IN) 2 (OUT) 3 (GND)

Connector M12x1

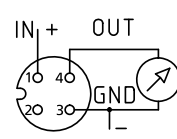

1 (IN) 4 (OUT) 3 (GND)

Connector M12x1

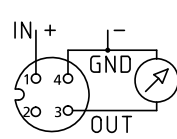

1 (IN) 3 (OUT) 4 (GND)

Connector M12x1

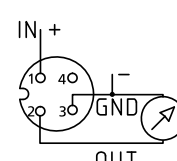

1 (IN) 2 (OUT) 3 (GND)

Metri Pack Serie 150

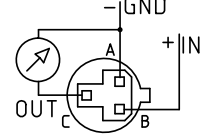

B (IN) C (OUT) A (GND)

Braids

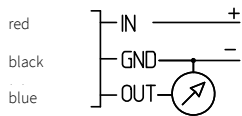

Connector RAST 2.5

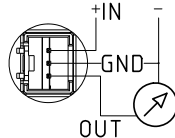

Device design with explosion protection: 4 ... 20 mA
The grounding connection is conductively connected to the transmitter housing.

Connector DIN
EN 175301-803-A

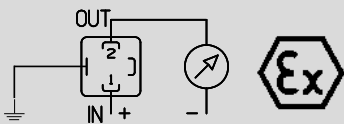

1 (IN) 2 (OUT) ↓

Connector M12x1

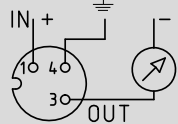

1 (IN) 3 (OUT) 4 (↓)

Device design with explosion protection: ratiom. 10 ... 90%
The electronic GND is connected with a 1MΩ resistor to the transmitter housing.

Connector DIN
EN 175301-803-A

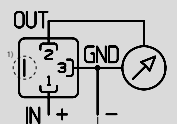

1 (IN) 2 (OUT) 3 (GND)

Connector M12x1

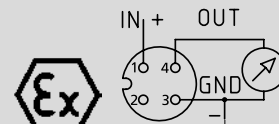

1 (IN) 3 (GND) 4 (OUT)

In Proud Partnership with Huba Control

PAQUIN
SENSORS

For technical support, sales, & distribution
within the USA & Canada

www.paquin.com | (800) 831-8217 | paquinsensors@paquin.com

¹⁾ Not connected with transmitter housing